

# 1188 SERIES

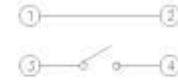

## DIMENSIONS

### 1188-1

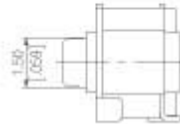
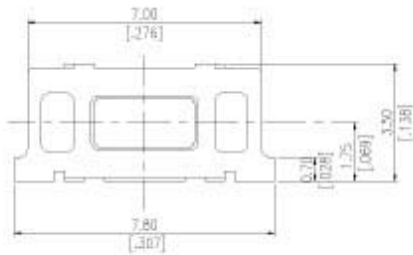
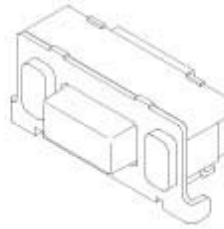
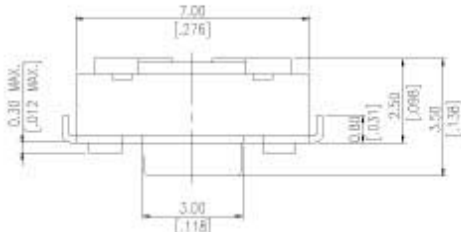

**CIRCUIT**

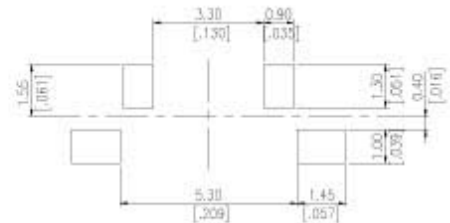
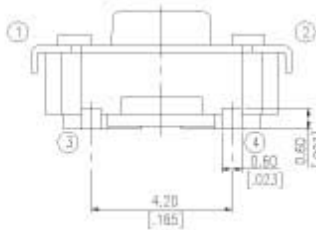

**P.C.B. LAOUT**

PART NO.	COLOR OF STEM	OPERATING FORCE
1188-1K2	BLACK	160±50gf
1188-1W3	WHITE	260±50gf

General Tolerance : ±0.2mm

### 1188E-1

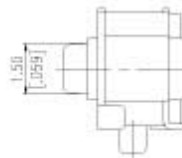
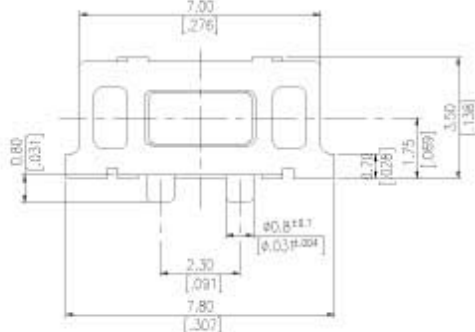
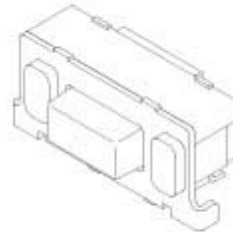
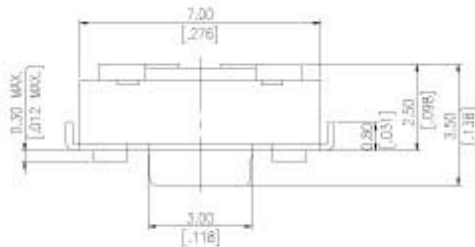

**CIRCUIT**

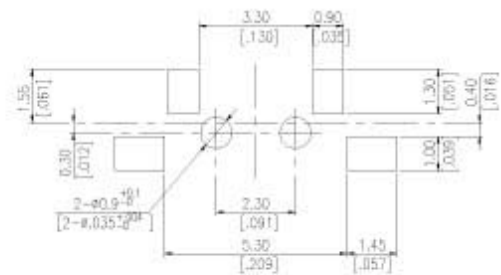
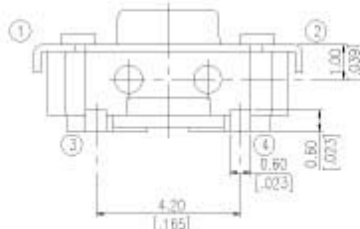

**P.C.B. LAOUT**

PART NO.	COLOR OF STEM	OPERATING FORCE
1188E-1K2	BLACK	160±50gf
1188E-1W3	WHITE	260±50gf

General Tolerance : ±0.2mm

# 1188EP-1

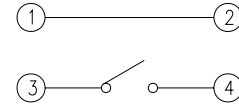
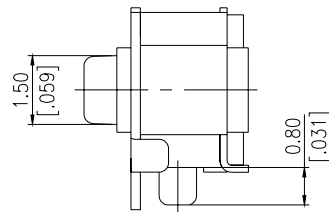
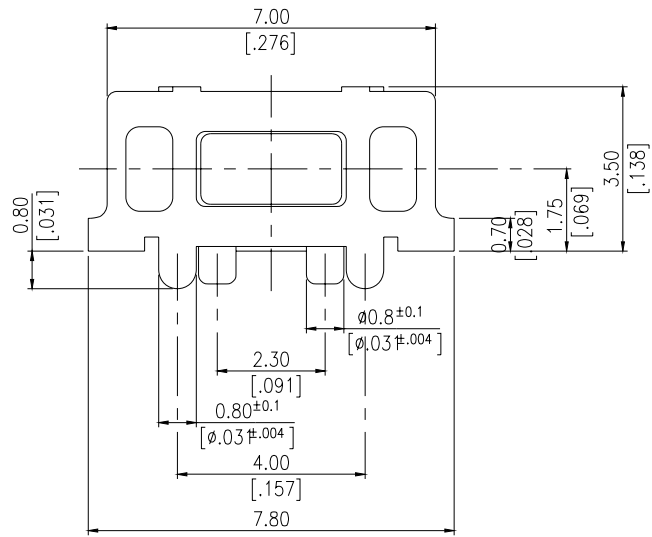
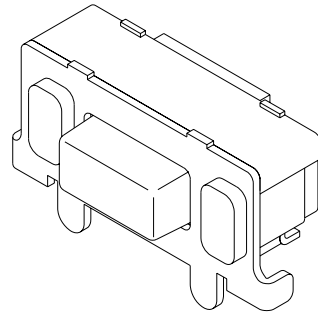
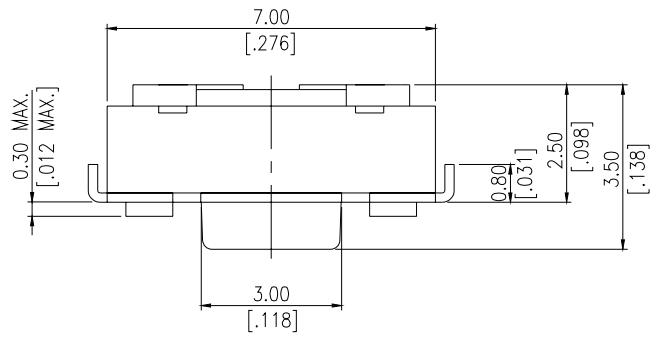

**CIRCUIT**

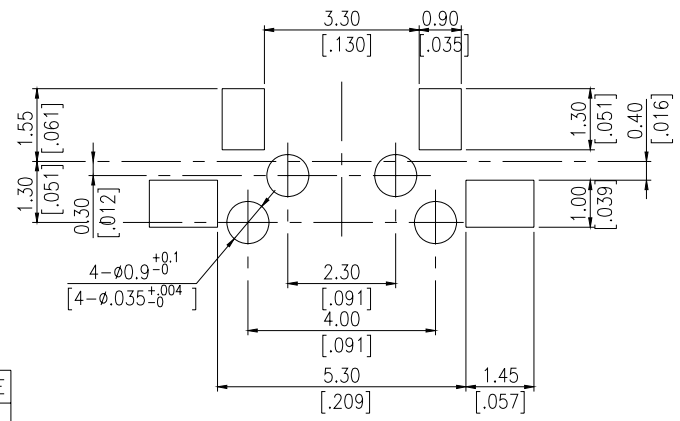
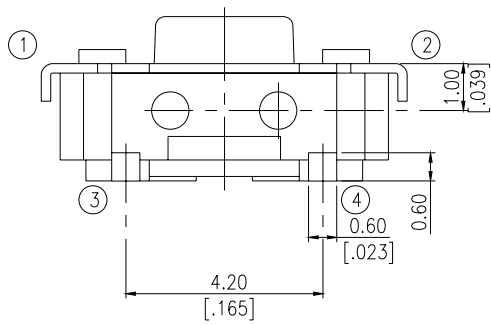

**P.C.B. LAOUT**

PART NO.	COLOR OF STEM	OPERATING FORCE
1188EP-1K2	BLACK	160±50gf
1188EP-1W3	WHITE	260±50gf

General Tolerance : ±0.2mm

# 1188P-1

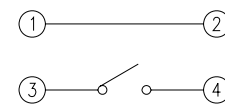
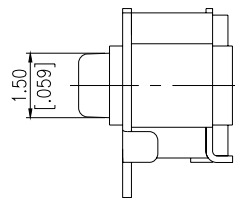
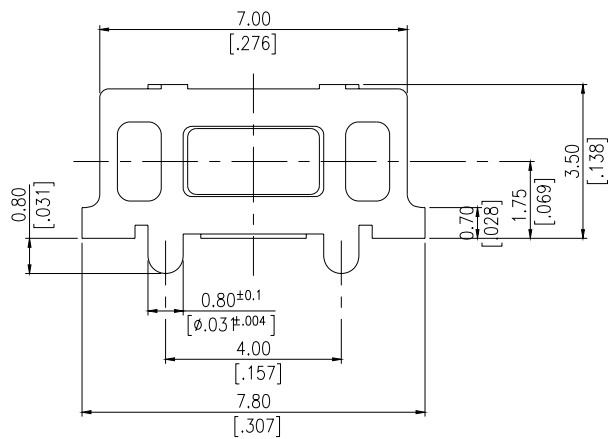
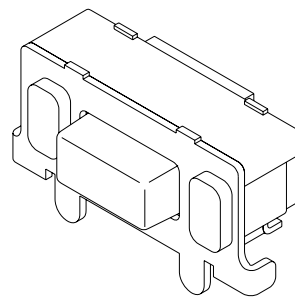
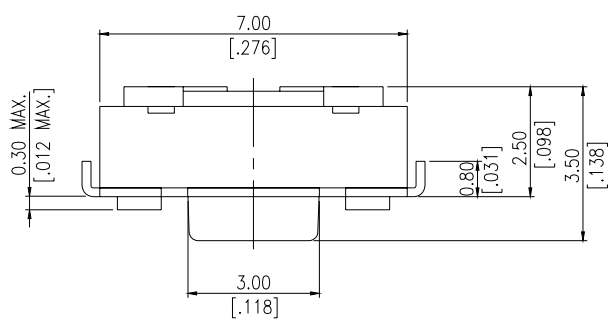

**CIRCUIT**

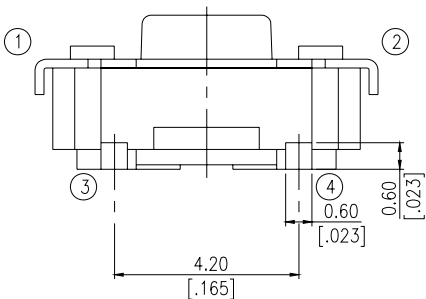

PART NO.	COLOR OF STEM	OPERATING FORCE
1188P-1K2	BLACK	160±50gf
1188P-1W3	WHITE	260±50gf

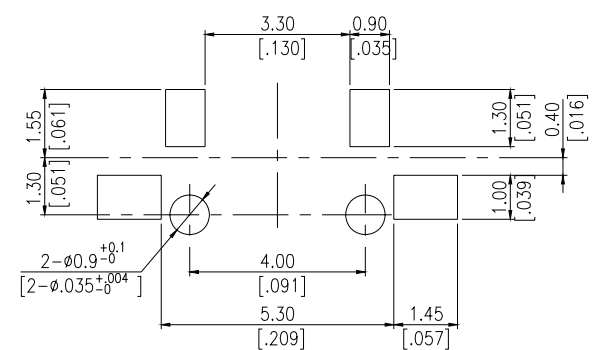

**P.C.B. LAOUT**

General Tolerance : ±0.2mm

# HOW TO ORDER

1188 □ - □ □ - □ - □

Package Style:  
T/R = Tape & Reel

Solder:  
V=Lead Free Solderable

Operating Force  
2 = 160gf  
3 = 260gf

Color of Stem:  
K= Black  
W = White

Stem Height:  
1 = 1.0mm

Pilot:  
□ = Without Pilot  
E = Base with Pilot  
P = Cover with Pilot  
EP= Base + Cover with Pilot  
Extra Thin Side actuated Tact Switch

## SPECIFICATION

### △MECHANICAL

Operation Force: 2=160gf ± 50gf  
3=260gf ± 50gf

Stroke: 0.25 +0.10 / - 0.1 mm

Operation Temperature: -25°C to +70°C

Storage Temperature: -40°C to +80°C

### △ELECTRICAL

Electrical Life: 50,000 cycles for 160gf  
30,000 cycles for 260gf

Rating: 50mA , 12VDC

Contact Resistance: 100mΩ max.

Insulation Resistance: 100MΩ min. at 500VDC

Dielectric Strength: 250 V AC/ minute

Contact Arrangement: 1 pole 1 throw

## MATERIAL

△COVER Steel : Nickel Silver

△BASE: UL94V-0 Nylon High – Temp. Thermoplastic  
Color: White

△STEM: UL94V-0 Nylon High – Temp. Thermoplastic  
Color: Black (160gf), White (260gf)

△CONTACT DISC: Stainless with silver cladding

△TERMINAL: Brass with silver plated

## SOLDERING PROCESS

For best results, please follow these recommendation:

△HAND SOLDERING: Use a soldering iron of 30 watts, controlled at 350°C approximately max 5 seconds.

△REFLOW SOLDERING: When applying reflow soldering, the peak temperature or the reflow Oven should be set at 260°C max.

△Reflow Temperature Profile:

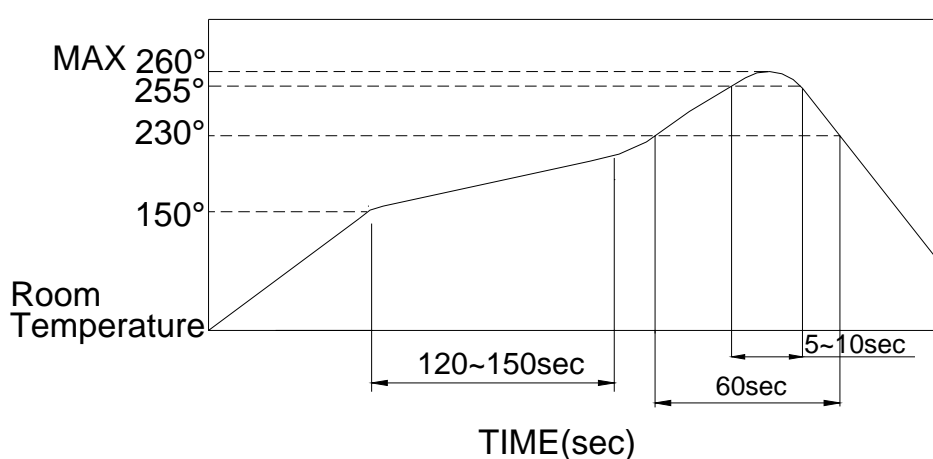

# PACKING

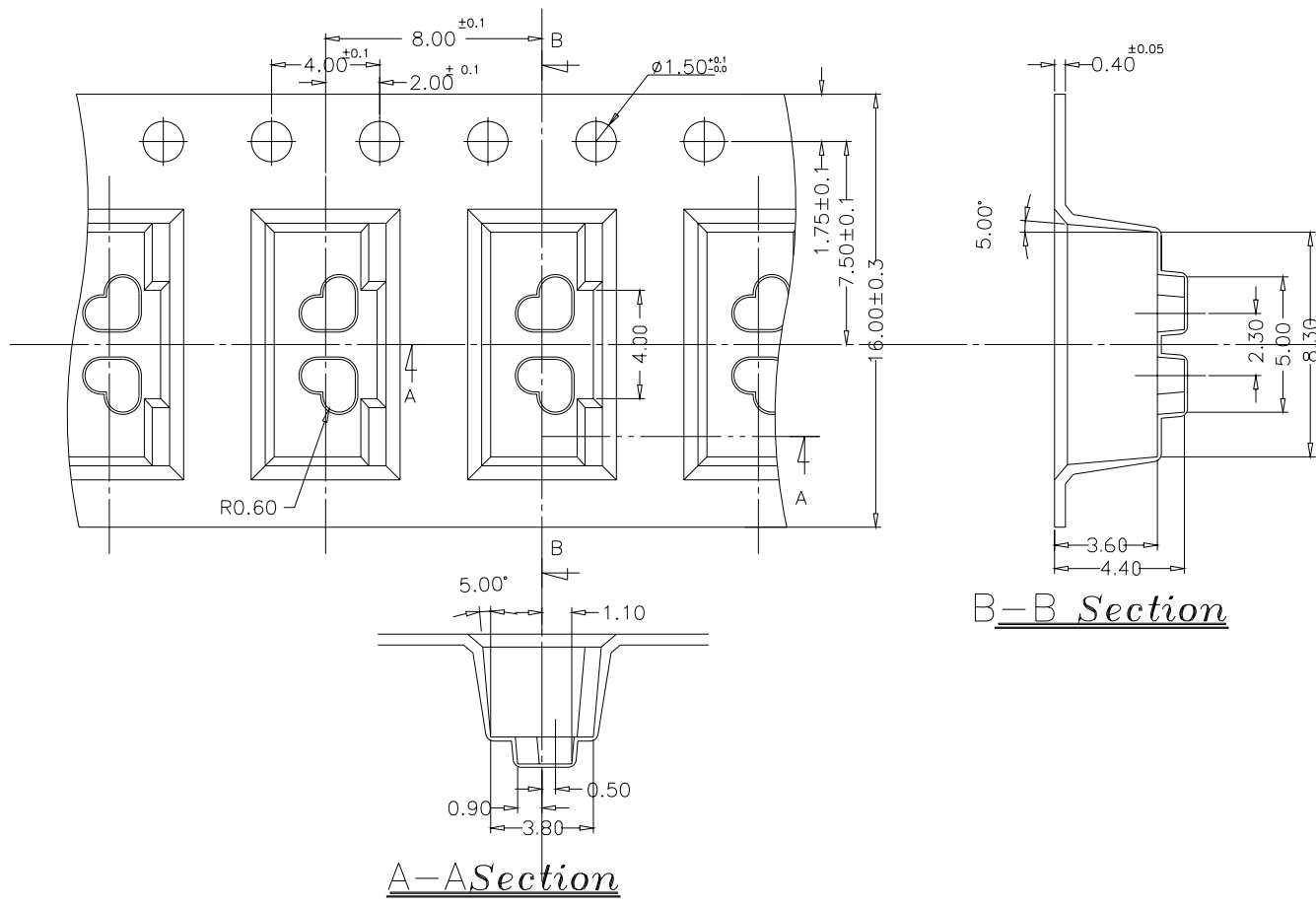

Part Number	Number Per Reel
1188-1	2000
1188E-1	
1188EP-1	
1188P-1	

General Tolerance :  $\pm 0.1\text{mm}$