

# Waterproof Multi-function Switches Series SF19BA



**Feature**

- Panel cutting Ø19mm
- Front Panel IP65
- 5 Key Navigation Switches
- LED Illuminated
- Metal Housing

**General Specifications**

Switch Circuit :SP5T (5-key Common bus)  
 Switch contact rating :50mA @ 12V DC max  
 LED Rating :30mA @ 12V DC  
 Contact Resistance :300mΩ Max.  
 Insulation Resistance :100MΩ Min.  
 Operating Force :Center Push 650±200gf  
 4-Direction 250±100gf  
 Mechanical Life :50,000 cycles Min.  
 Operating Temperature :-20 °C ~ +70 °C

**Materials**

Cap(Type 1,Type 2) :Polyamide (PA)  
 Cap(Type 3) Polycarbonate (PC)  
 Reflector :Silicone  
 Base :PC  
 Housing :SUS  
 Nuts :Polyamide (PA)  
 Washer :Rubber

**Dimension**

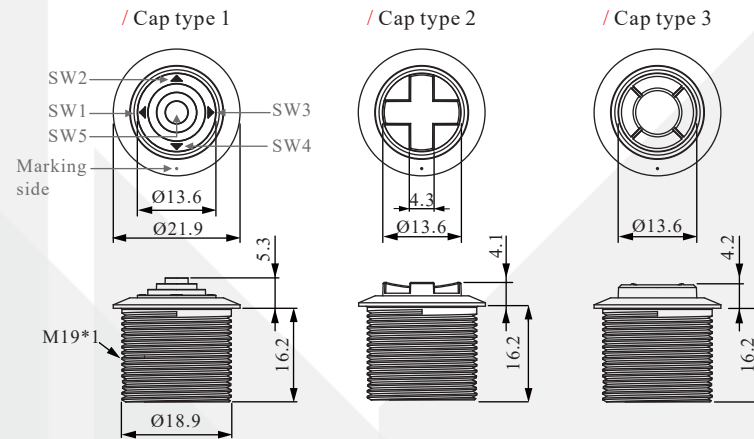

**Option**

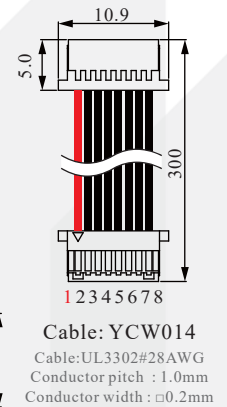

**Contact Configuration & Panel cutting**

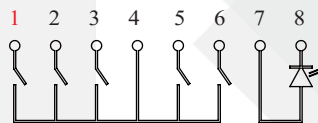

Pin	Function	Pin	Function
1	SW3 N.O.	5	SW4 N.O.
2	SW2 N.O.	6	SW5 N.O.
3	SW1 N.O.	7	LED(+)
4	SW COM.	8	LED(-)

The Connector for SF19BA module similar JST BM08B-SRSS-TB  
 Applicable Connector:  
 Conductor pitch / 1.0mm  
 Conductor width / □0.2mm

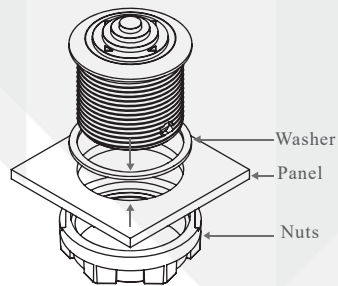

Installation Notes

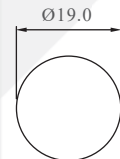

Panel thickness 1.5~4.0mm

**How to order**



**SF19BA0B11**  
Without LED /  
Silver Housing /  
Black Cap type 1



**SF19BA7B12**  
Blue LED /  
Silver Housing /  
Black Cap type 2



**SF19BA7A13**  
Blue LED /  
Black Housing /  
Black Cap type 3