

BODY TYPE

A0/G3

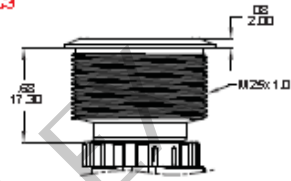

PANEL MOUNTING

Max. Panel thickness : 10.0mm [39]

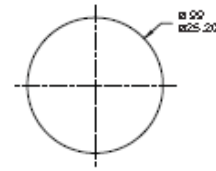

LIGHT TYPE

E Ring Moveable

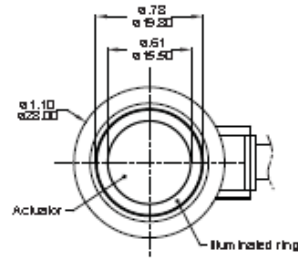

L Ring+Power logo

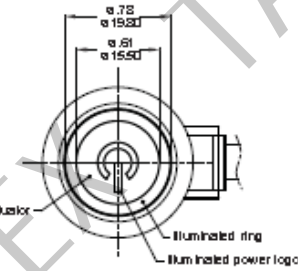

DIMENSION

E Ring Moveable

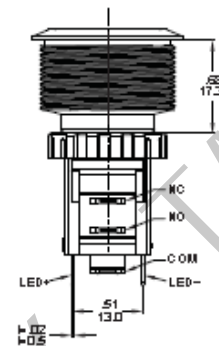
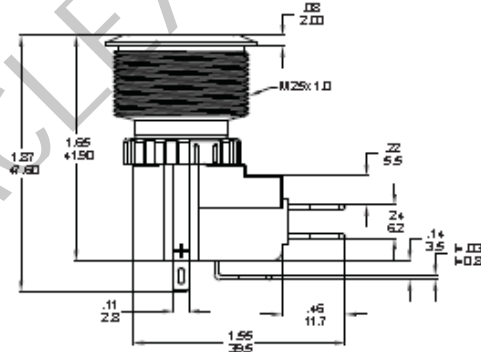
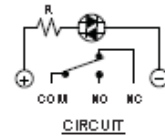
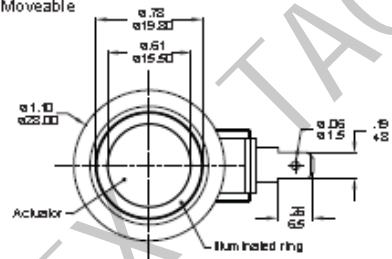

Part No. Shown : MM025-ADF ET 12-A3ZA