

TL(L)-6 SERIES

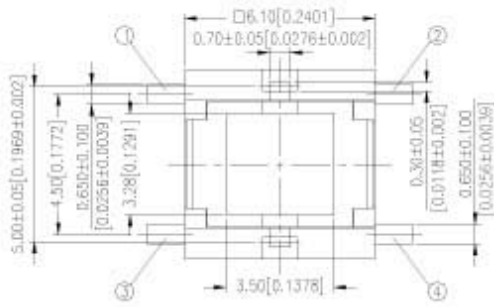

DIMENSIONS

TL-6



Part No.	OF	Color
TL-61-V	100±50g	K-Black
TL-62-V	160±50g	N-Brown
TL-63-V	260±50g	W-White

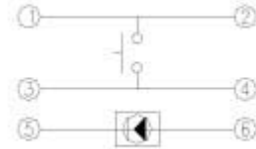

CIRCUIT DIAGRAM

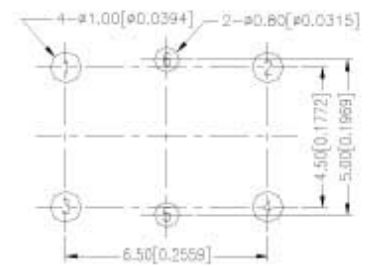
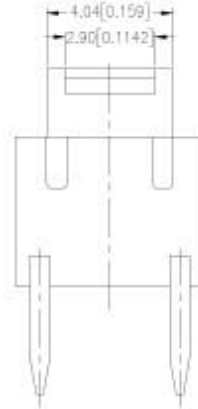
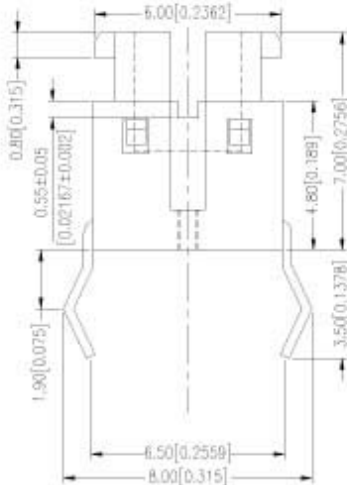

P.C.B LAYOUT

General Tolerance : ±0.2mm

TLL-6A

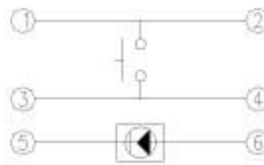
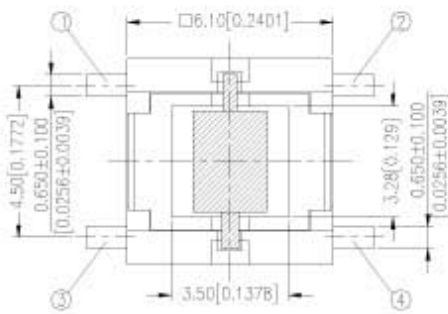

CIRCUIT DIAGRAM

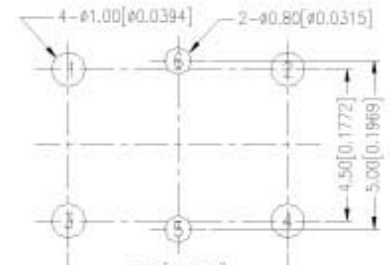

P.C.B LAYOUT

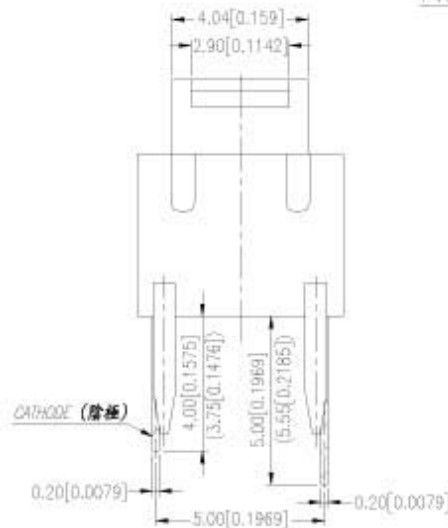
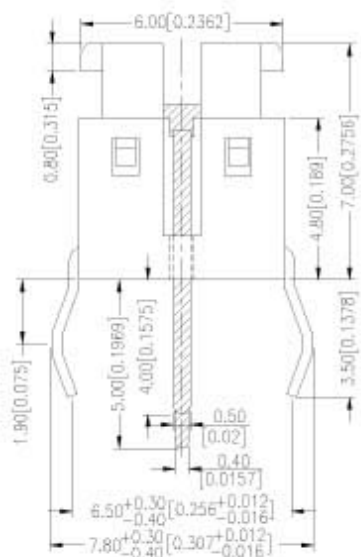

General Tolerance : ±0.2mm

TLL-6B

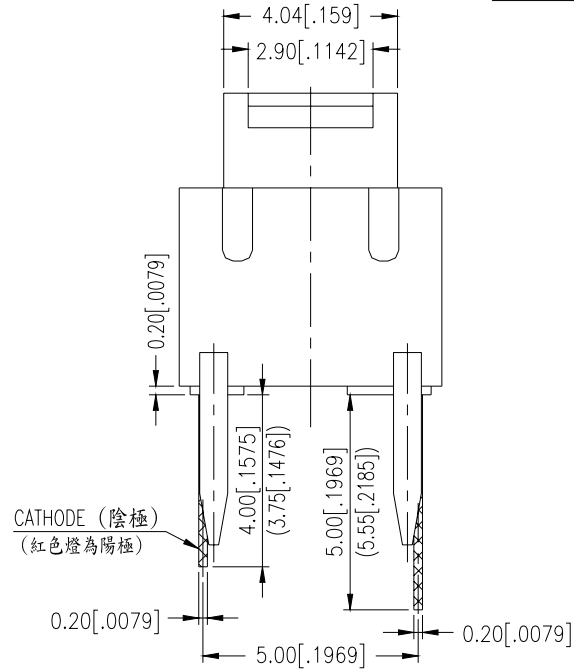
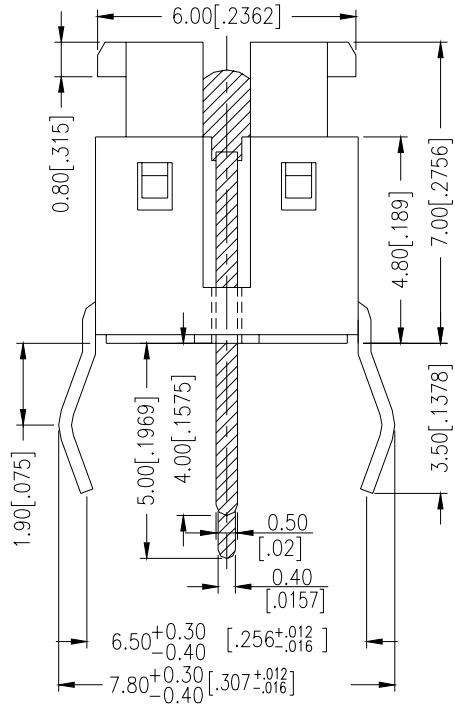
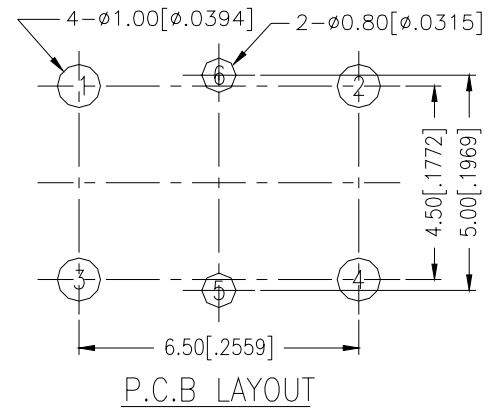
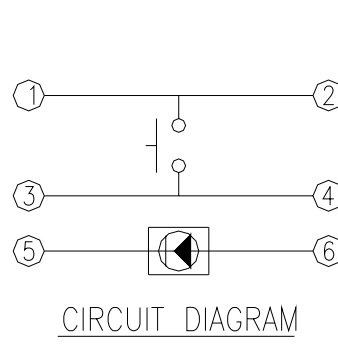
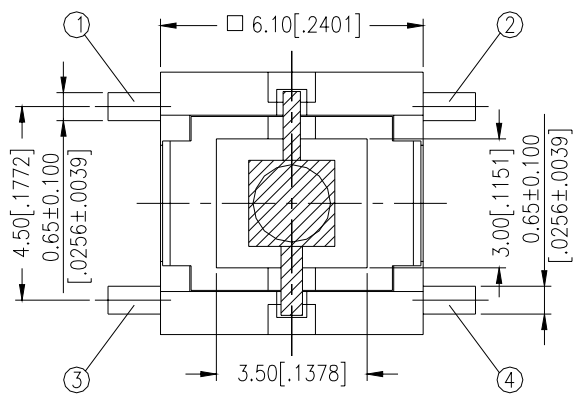

General Tolerance : $\pm 0.2\text{mm}$

TLLM-6

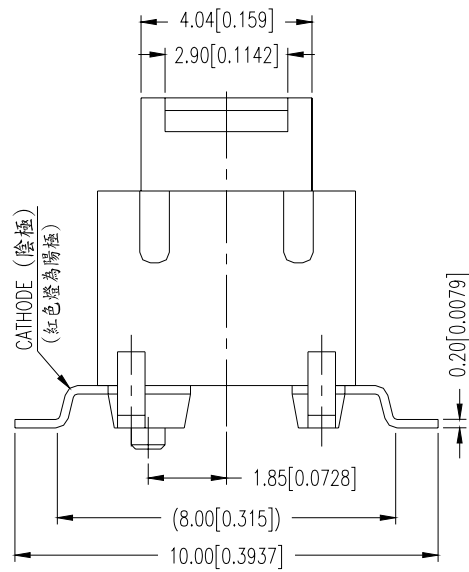
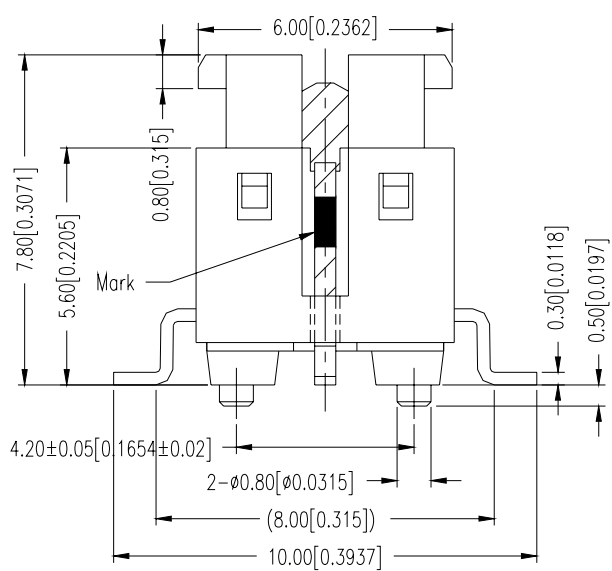
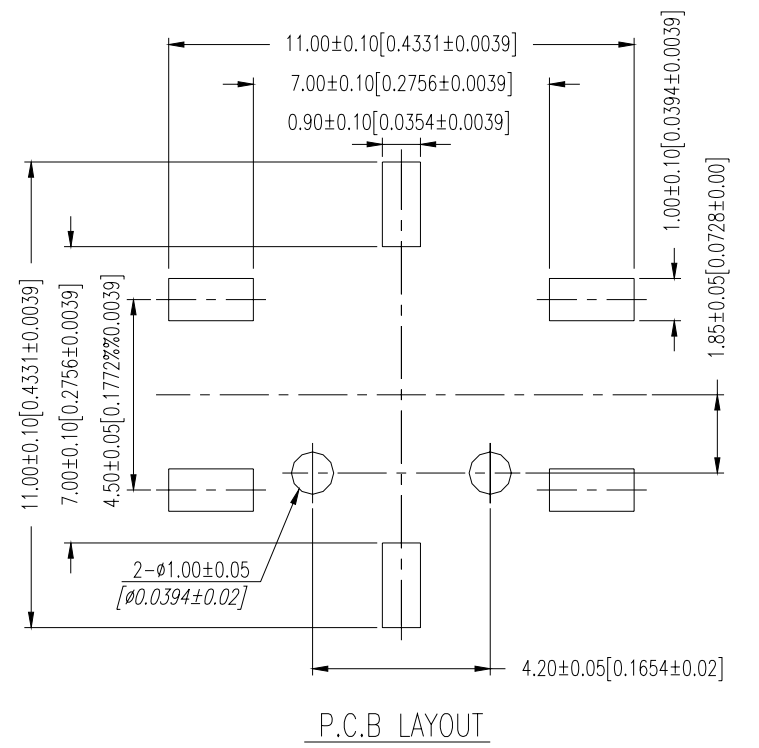
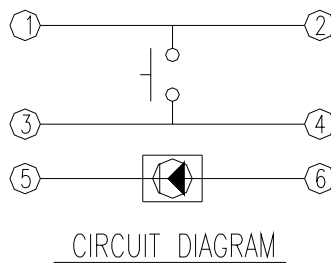
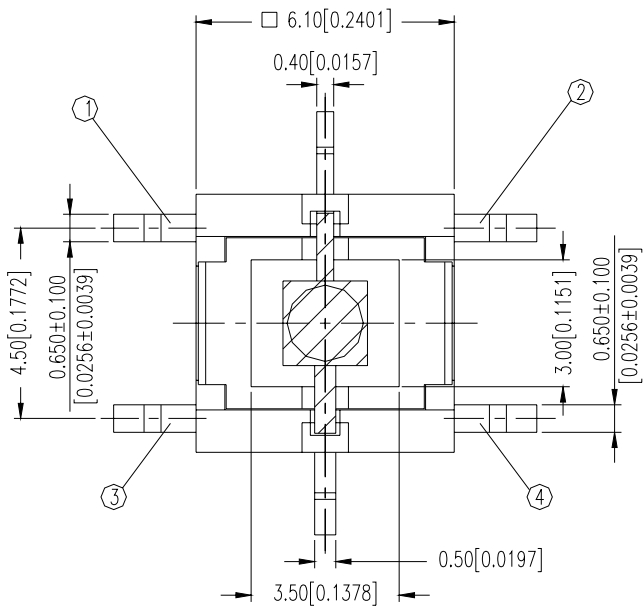

General Tolerance : $\pm 0.2\text{mm}$

HOW TO ORDER

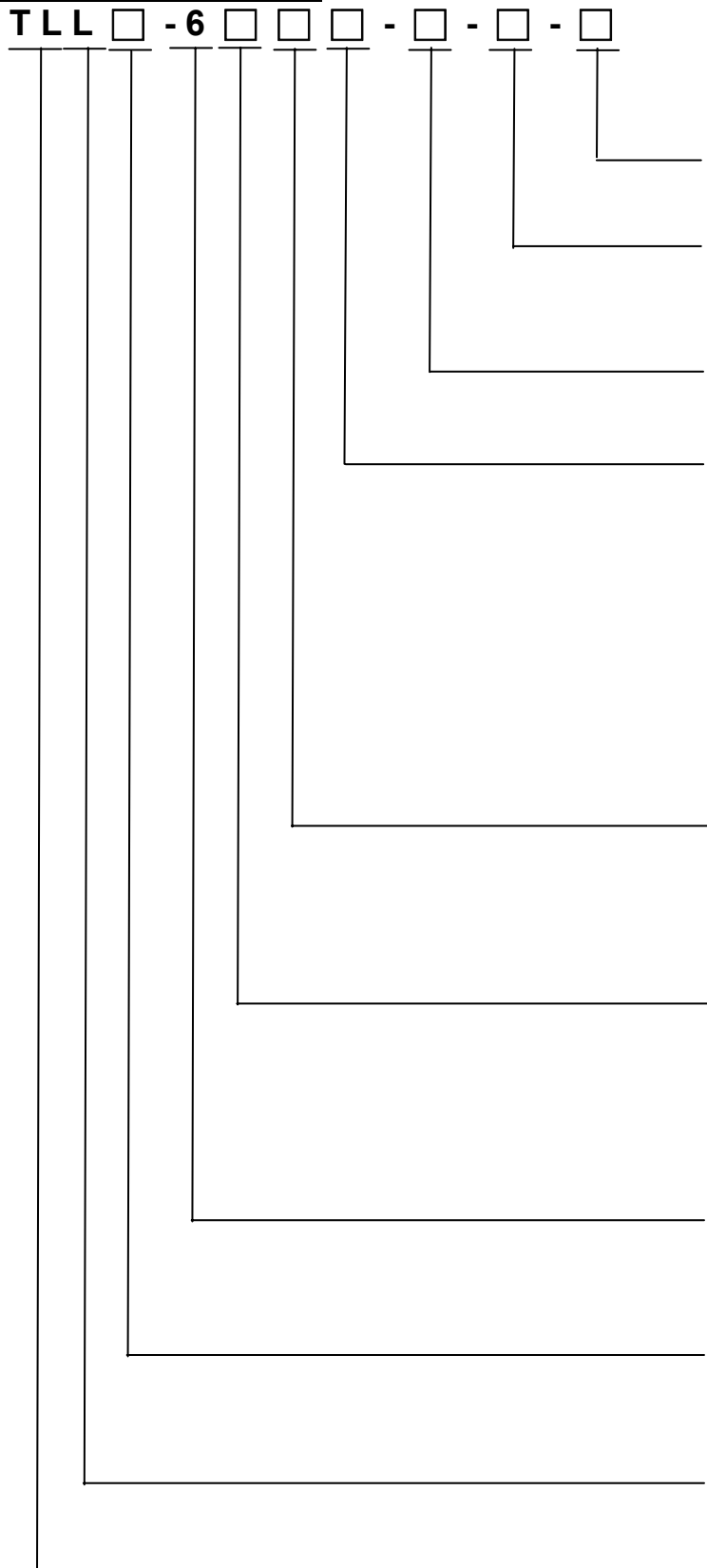

Package Style :

B = Tube

Soldering :

V = Lead Free Solderable

S = Super Bright

LED Color :

R = Red ; G = Green

B = Blue ; Y = Yellow

O = Orange ; W = White <Only For TLL-6A>

RG = Red/Green ; GY = Green/Yellow

AG = Amber/Green

<Only For TLL-6B>

LED Specification :



Operating Force :

1 = 100gf, Black

2 = 160gf, Brown

3 = 260gf, White

Prod. Size :

6 = 6X6mm

= THT

M = S.M.T

L = Tact Switch + LED

Tact Switch Type

SPECIFICATION

△MECHANICAL

Operation Force:

100 ± 50gf TL(L)-61

160 ± 50gf TL(L)-62

260 ± 50gf TL(L)-63

Stroke: 0.20 + / - 0.10 mm

Operation Temperature: -25°C to +70°C

Storage Temperature: -30°C to +80°C

△ELECTRICAL

Electrical Life: 200,000 cycles min. for TL(L)-61,62,63

Rating: 50mA , 12VDC

Contact Resistance: 100mΩ max.

Insulation Resistance: 100MΩ min. 500VDC

Dielectric Strength: 250VAC/ minute

Contact Arrangement: 1 pole 1throw

MATERIAL

△CONTACT DISC: Stainless with silver cladding

△TERMINAL: Brass with silver cladding

△BASE: Nylon High-temp. thermoplastic

Color: Black

△STEM: NYLON High-temp. Thermoplastic

Color: Black / TL(L)-61

Brown / TL(L)-62

White / TL(L)-63

SOLDERING PROCESS

△WAVE SOLDERING : Recommended solder

Temperature at 500°F(260°C) max. 5 seconds.

subject to PBC 1.6mm thickness.

(Soldering for through hole type)

△HAND SOLDERING : Use a soldering iron of

30 watts, controlled at 350°C approximately max 5

seconds while applying solder.

PACKING

Part Number	Number Per Tube	
TL(L)-6	75	

TL-6

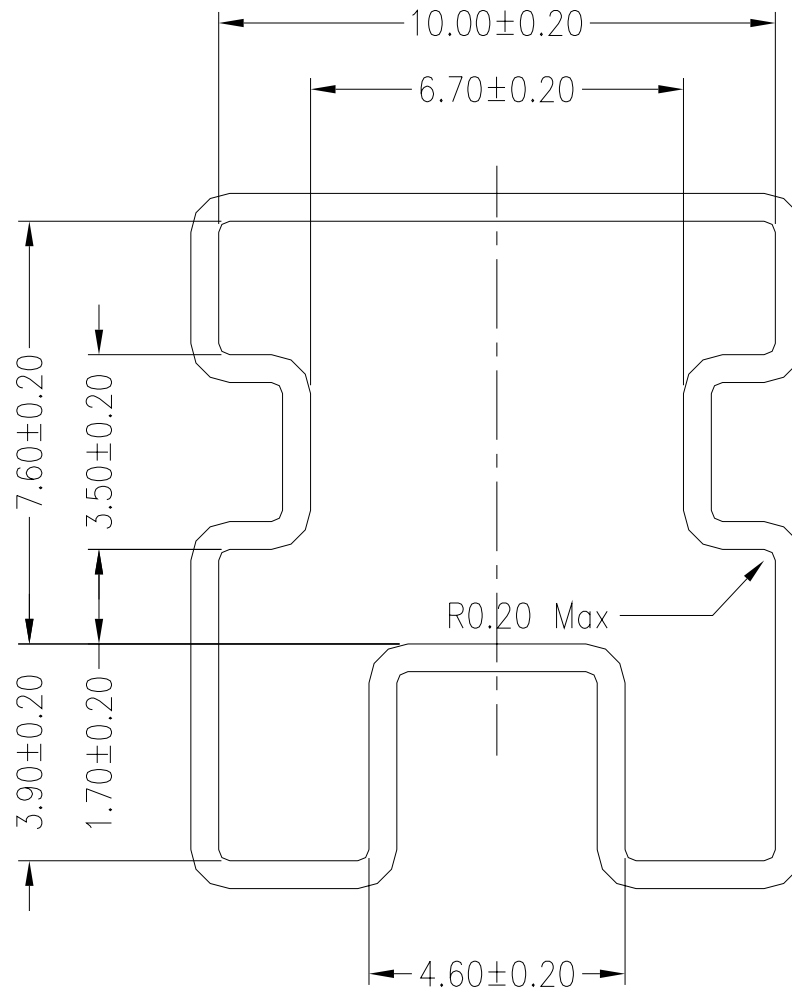

General Tolerance : $\pm 0.2\text{mm}$

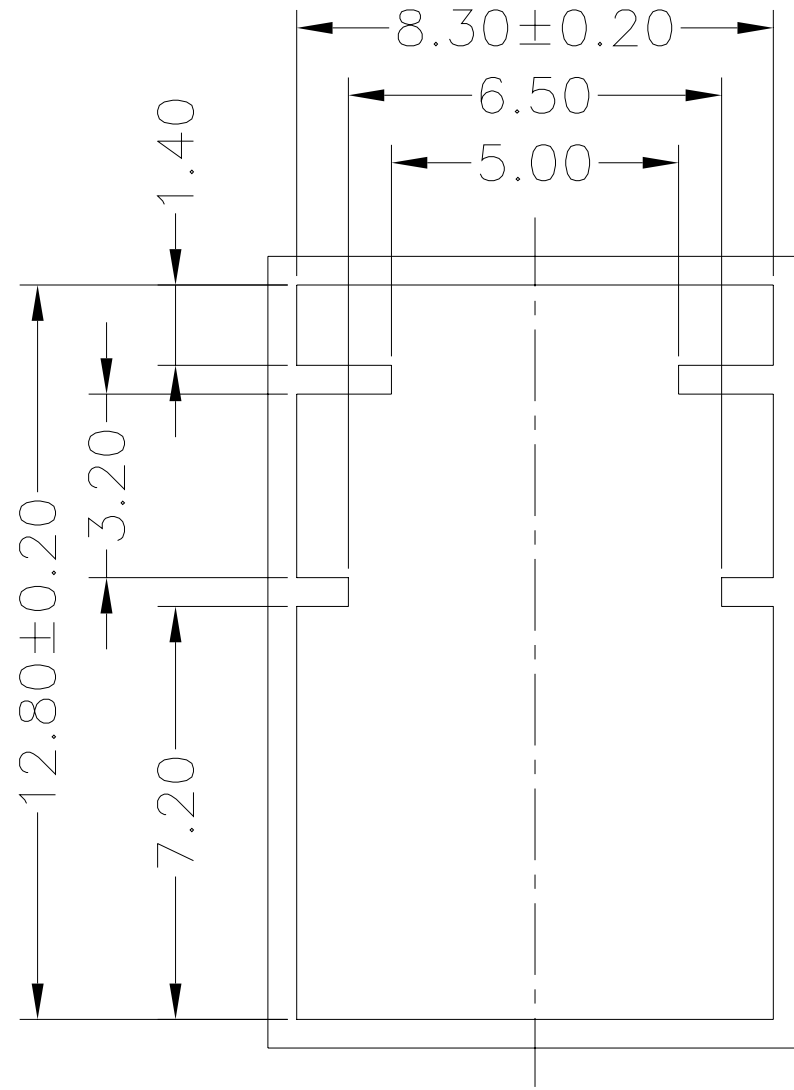

General Tolerance : $\pm 0.2\text{mm}$