

DTSM(G)-6(2) SERIES

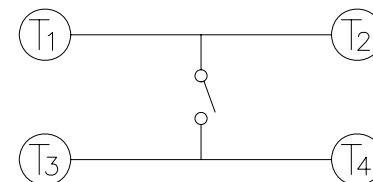

DIMENSIONS

DTSM-6

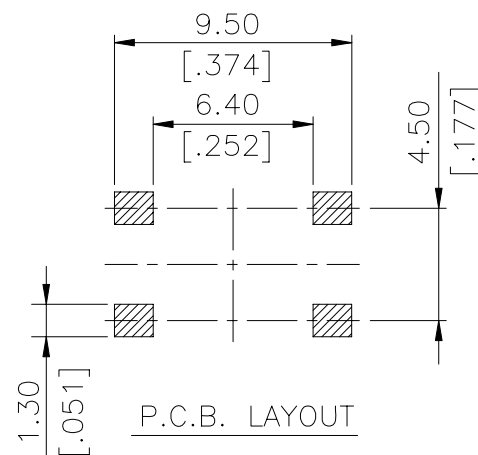
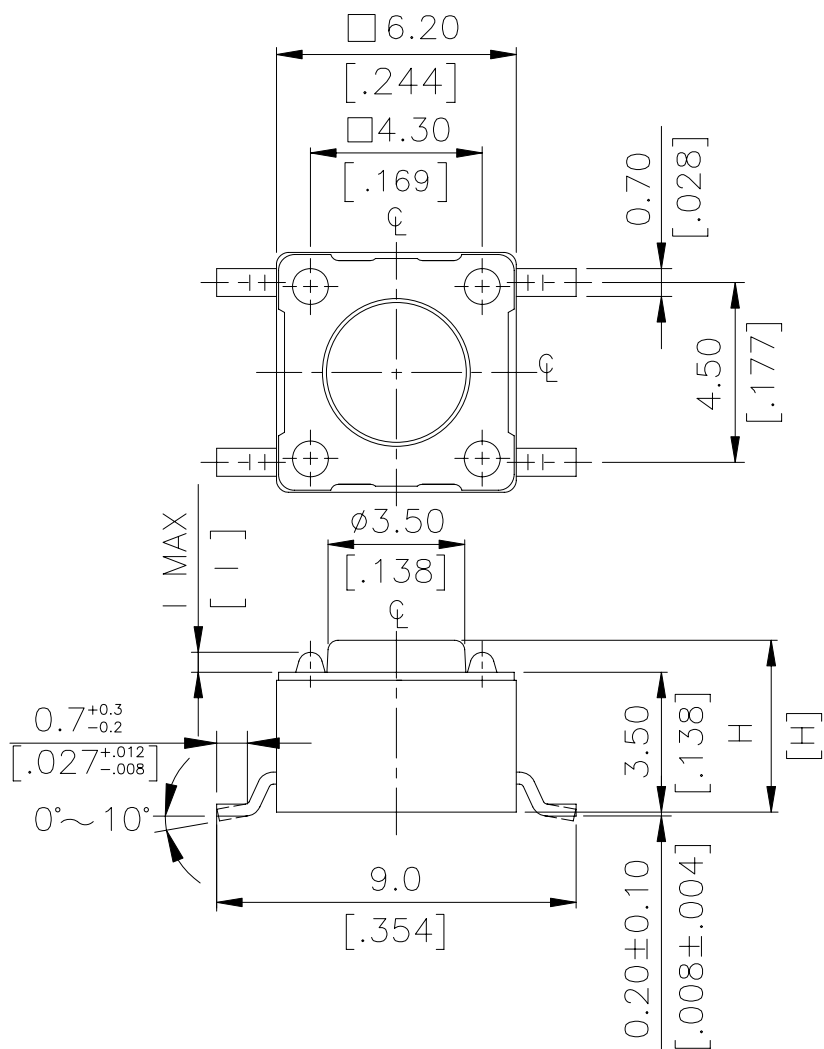

CIRCUIT DIAGRAM

| | | |
|-----------------|---------|----------|
| DTSM-62~66 □ -V | 0.6 MAX | .0236MAX |
| DTSM-61 □ -V | 0.5 MAX | .0197MAX |
| PROD. NO. | I | INCHES. |

| | | |
|--------------|------|--------|
| DTSM-66 □ -V | 13.0 | [.512] |
| DTSM-65 □ -V | 9.5 | [.374] |
| DTSM-63 □ -V | 7.0 | [.275] |
| DTSM-62 □ -V | 5.0 | [.197] |
| DTSM-61 □ -V | 4.3 | [.169] |
| PROD. NO. | H | |

General Tolerance : $\pm 0.2\text{mm}$

DTSM-64 □

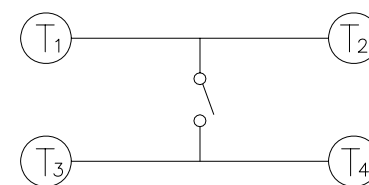
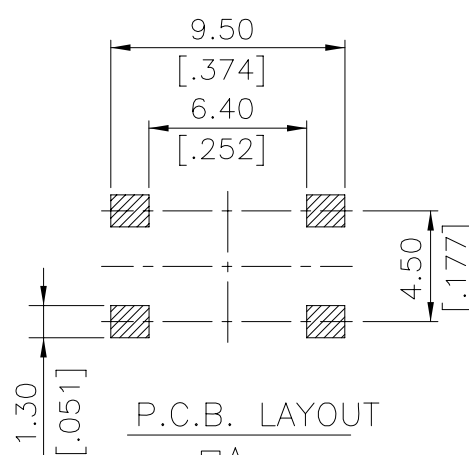
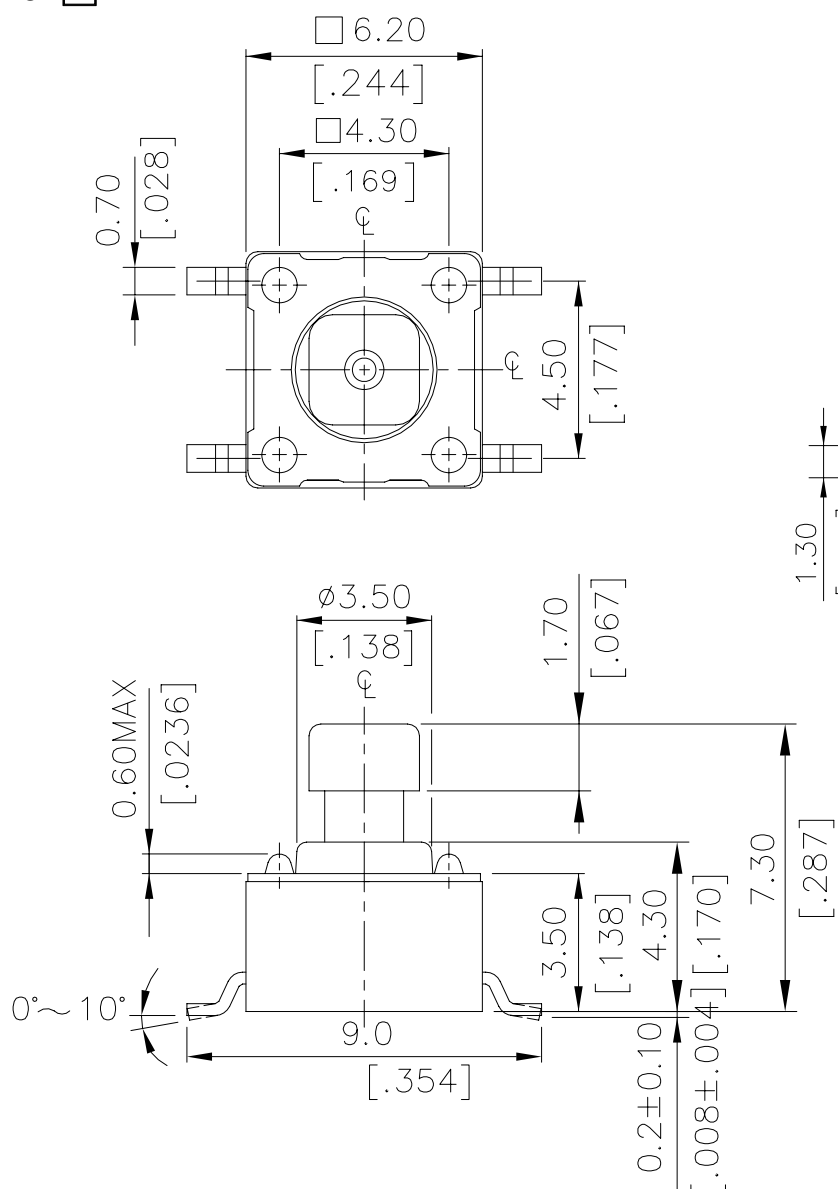

CIRCUIT DIAGRAM

| | | | |
|---------------|------|-----|--------|
| DTSM-644 □ -V | □A | 2.4 | [.095] |
| | □B | 1.6 | [.063] |
| DTSM-648 □ -V | □A | 2.8 | [.110] |
| | □B | 2.0 | [.079] |
| PROD. NO. | LOC. | MM. | INCH. |

DIMENSION

General Tolerance : $\pm 0.2\text{mm}$

DTSMG-6

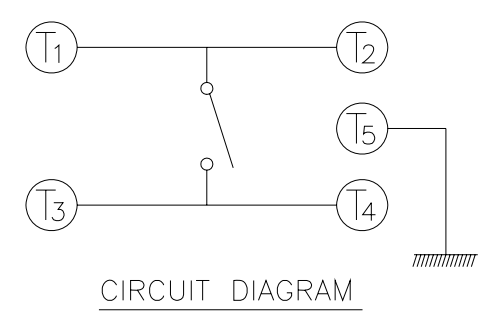
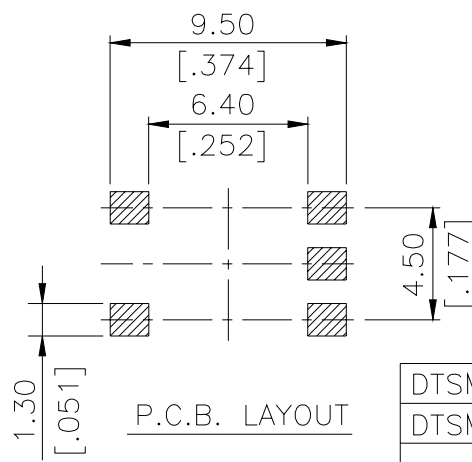
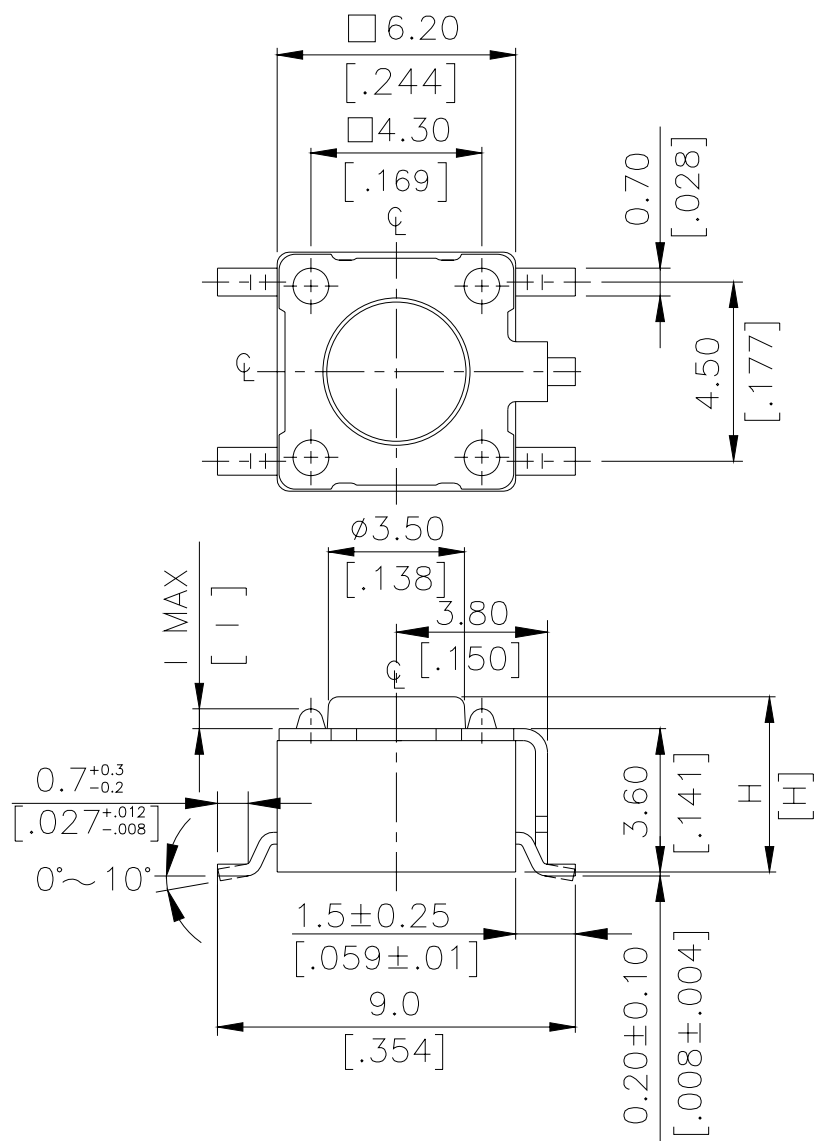

| | | |
|----------------|---------|---------|
| DTSMG-62~66□-V | 0.5 MAX | .02MAX |
| DTSMG-61□-V | 0.4 MAX | .016MAX |
| PROD. NO. | I | INCHES. |

| | |
|-----------------|--------------|
| DTSMG- 6 6 □ -V | 13.0 [0.512] |
| DTSMG- 6 5 □ -V | 9.5 [0.374] |
| DTSMG- 6 3 □ -V | 7.0 [0.275] |
| DTSMG- 6 2 □ -V | 5.0 [0.197] |
| DTSMG- 6 1 □ -V | 4.3 [0.169] |
| PROD. NO. | H |

General Tolerance : ±0.2mm

DTSM-2

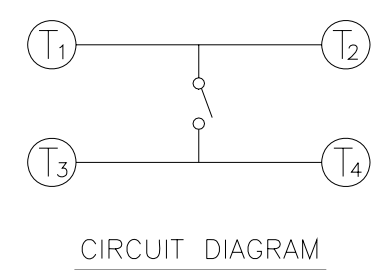
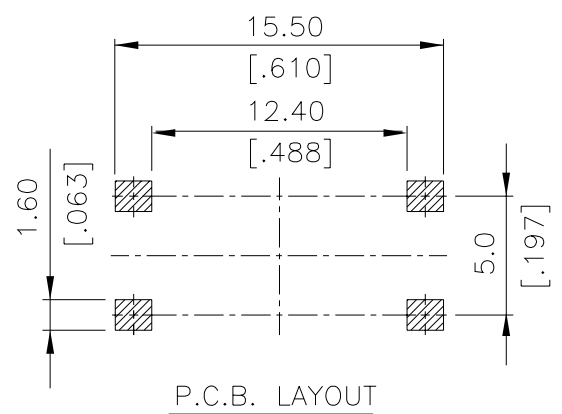
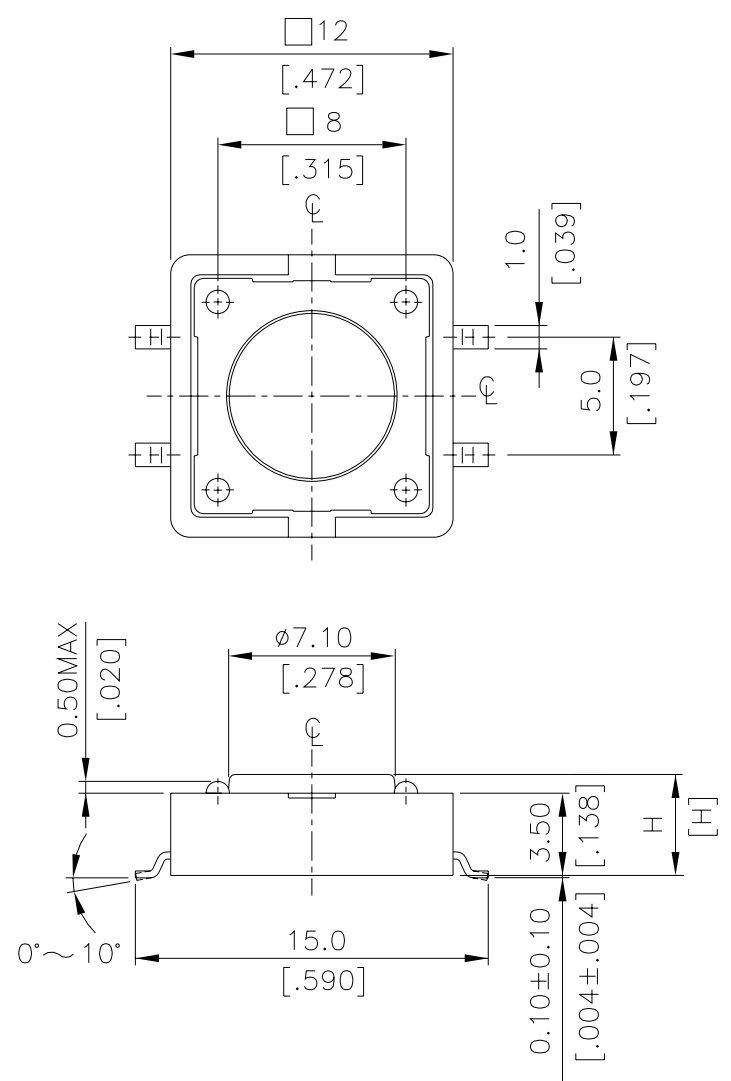

| | |
|---------|------------|
| DTSM-25 | 8.5[0.335] |
| DTSM-21 | 4.6[0.169] |
| PART NO | H |

General Tolerance : ±0.2mm

DTSM-24

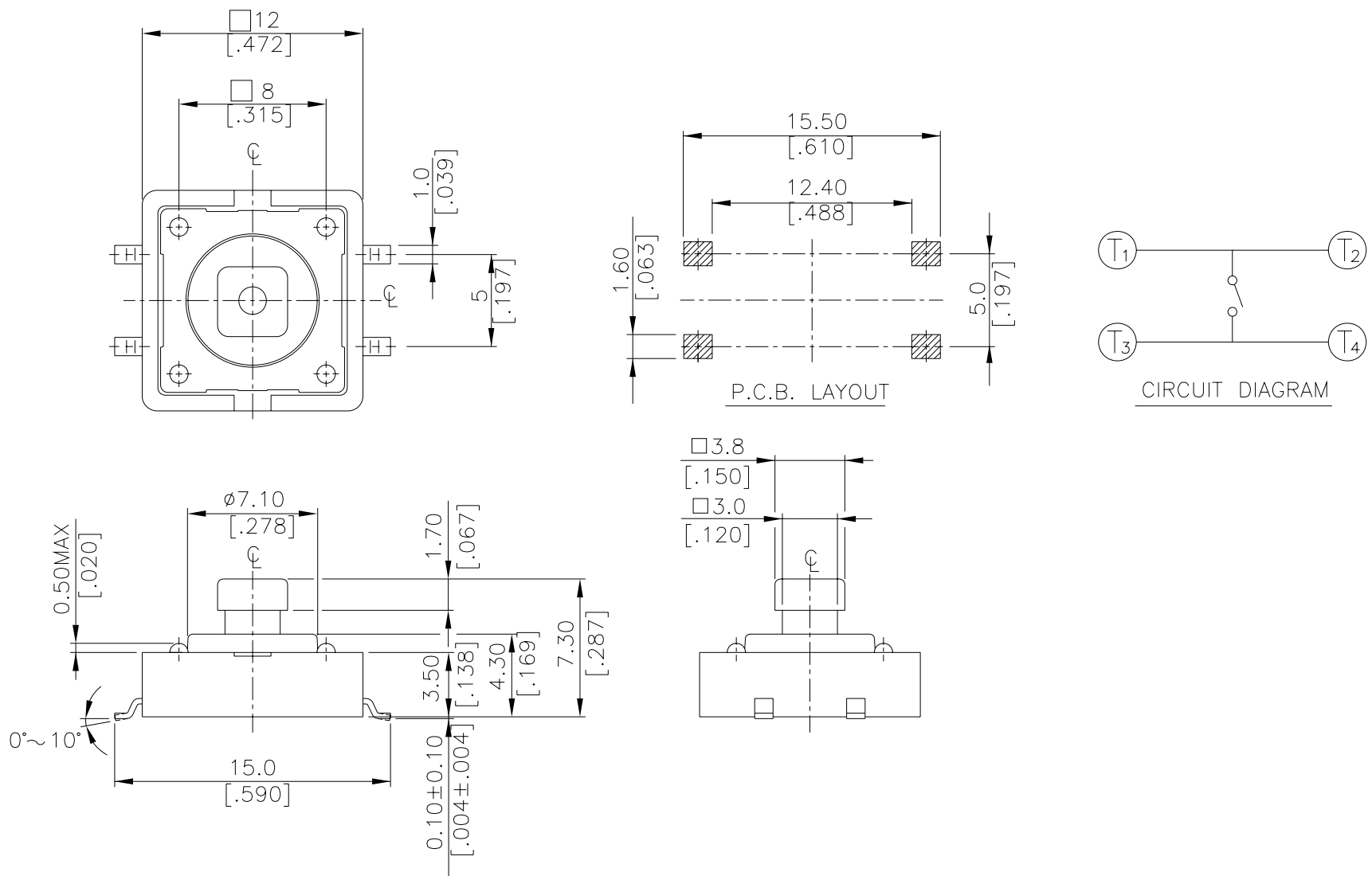

General Tolerance : ±0.2mm

HOW TO ORDER

DTSM □ - □ □ □ □ - □ - □

- Package style :
B=Tube
T/R=Tape&Reel <▲ Except DTSM-66>
- Soldering :
V=Lead Free Solderable
- =Phosphor Bronze Dome
S= Stainless Steel Dome
- Color Of Stem For Operating Force :
K=Black,100gf
N=Brown,160gf
R=Red,260gf
S=Salmon,320gf
Y=Yellow,520gf
- Dimension H :
1=4.3mm
2=5.0mm
3=7.0mm
44=7.3mm(SQ)X2.4mm
48=7.3mm(SQ)X2.8mm
5=9.5mm
6=13mm
- Prod Size :
6=6X6mm
- =Without Ground Terminal
G=With Ground Terminal
- Surface-Mourting Type Tactile Switch (Non-Washable)**

DTSM - □ □ □ - □ - □ - □

Package Style :
B = Tube
T/R = Tape & Reel

Soldering :
V = Lead Free Solderable

□ = Phosphor Bronze Dome
(*S = Stainless Steel Dome)
(*12X12 K、S、Y Unavailable)

Color Of Stem For Operating Force :
N = Brown, 160gf
R = Red, 260gf
S = Salmon, 320gf

Dimension H :
1 = 4.3mm
4 = 7.3mm(SQ)X3.8mm
5 = 8.5mm

Prod. Size :
2 = 12X12mm

Surface-Mounting Type Tactile Switch
<Non-Washable>

SPECIFICATION

△MECHANICAL

520 ± 130gf Yellow (Y)
320 ± 80gf Salmon (S)
Operation Force: 260 ± 50gf Red (R)
160 ± 50gf Brown (N)
100 ± 50gf Black (K)

Stroke: (6x6) 0.25 +0.2mm / -0.1mm
(12X12) 0.35 ±0.1mm

Operation Temperature: -25°C to +70°C

Storage Temperature: -30°C to +80°C

△ELECTRICAL(6x6)

Electrical Life: 1,000,000 cycles for 320gf, 520gf
500,000 cycles for 260gf
300,000 cycles for 100gf, 160gf

(Phosphor bronze)

ELECTRICAL (12X12)

Electrical Life: 100,000 cycles for 320gf
100,000 cycles for 260gf
200,000 cycles for 160gf

(Stainless Steel)

Electrical Life: 500,000 cycles for 260gf
1,000,000 cycles for 160gf

Rating: 50mA , 12VDC

Contact Resistance: 100mΩ max.

Insulation Resistance: 100MΩ min. at 500VDC

Dielectric Strength: 250VAC/ minute

Contact Arrangement: SPST

MATERIAL

△COVER: Stainless Steel(for DTSM-6、2)
Nickel Silver (for DTSMG-6)

△BASE: UL94V-0 Nylon High-Temp. Thermoplastic
Color: Black (Standard)
Color: Brown (V option)

△STEM: UL94V-0 Nylon High-Temp. Thermoplastic
Color: Black (100gf), Brown (160gf)
Red (260gf), Salmon (320gf)
Yellow (520gf)

△CONTACT DISC: Phosphor Bronze with silver cladding
(Standard)
Stainless Steel(V option)

△TERMINAL: Brass with silver plated

SOLDERING PROCESS

△ **HAND SOLDERING** : Use a soldering iron of 30 watts, controlled at 350°C approximately 5 seconds while applying solder.

△ **REFLOW SOLDERING** : When applying reflow soldering, the peak temperature or the reflow oven should be set to 260°C max.

△ **Temperature Profile:**

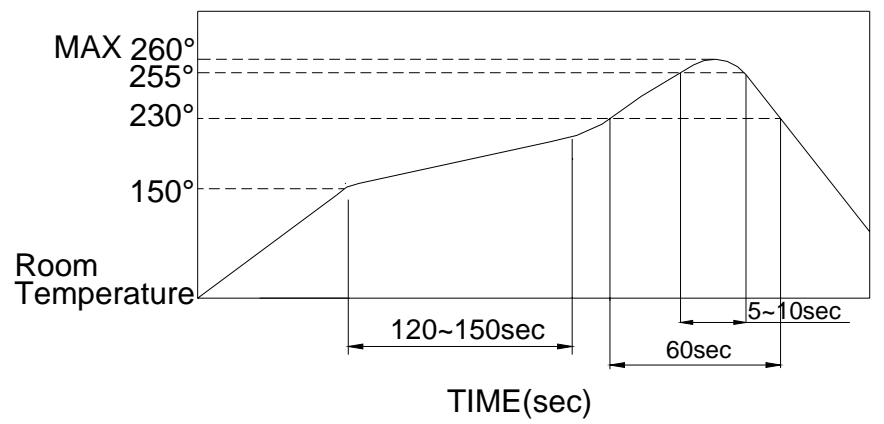

PACKING

| Part Number | Number Per Tube | Number Per Reel |
|--------------|-----------------|-----------------|
| DTSM-61 | 77 | 1000 |
| DTSMG-61 | - | 1000 |
| DTSM-62 | 77 | 900 |
| DTSMG-62 | - | 1000 |
| DTSM-63 | 77 | 700 |
| DTSMG-63 | - | 500 |
| DTSM-644(8) | 77 | 500 |
| DTSMG-644(8) | - | 500 |
| DTSM-65 | 77 | 380 |
| DTSMG-65 | - | 380 |
| DTSM-66 | 77 | - |
| DTS(M)-21 | 40 | 700 |
| DTS(M)-24 | 40 | 500 |
| DTS(M)-25 | 40 | 400 |

DTSM-2 REEL

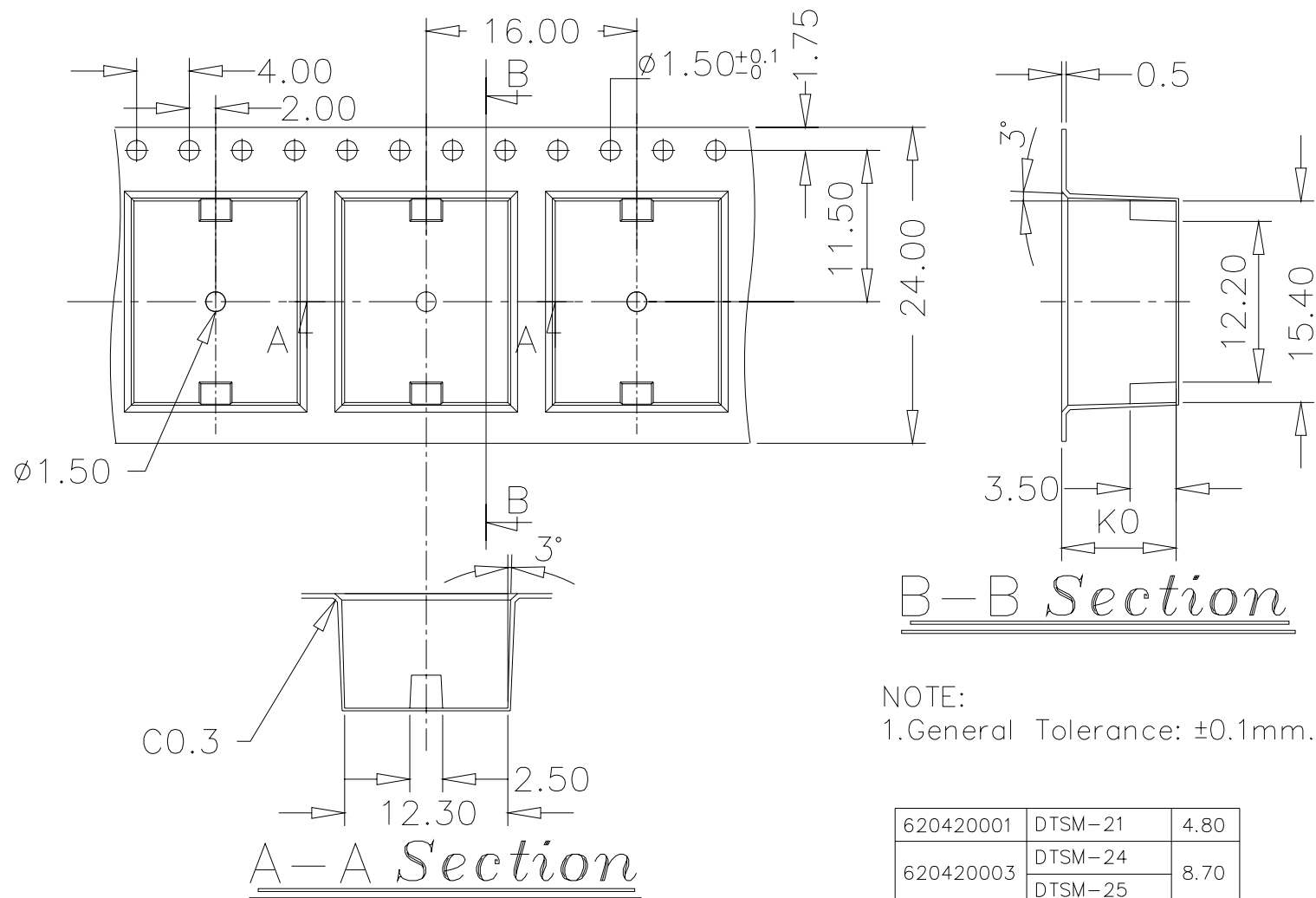

NOTE:
1. General Tolerance: ±0.1mm.

| | | |
|-----------|------------|------|
| 620420001 | DTSM-21 | 4.80 |
| 620420003 | DTSM-24 | 8.70 |
| | DTSM-25 | |
| PART NO: | PART NAME: | KO |

General Tolerance : ±0.1mm

DTSM-61.62 REEL

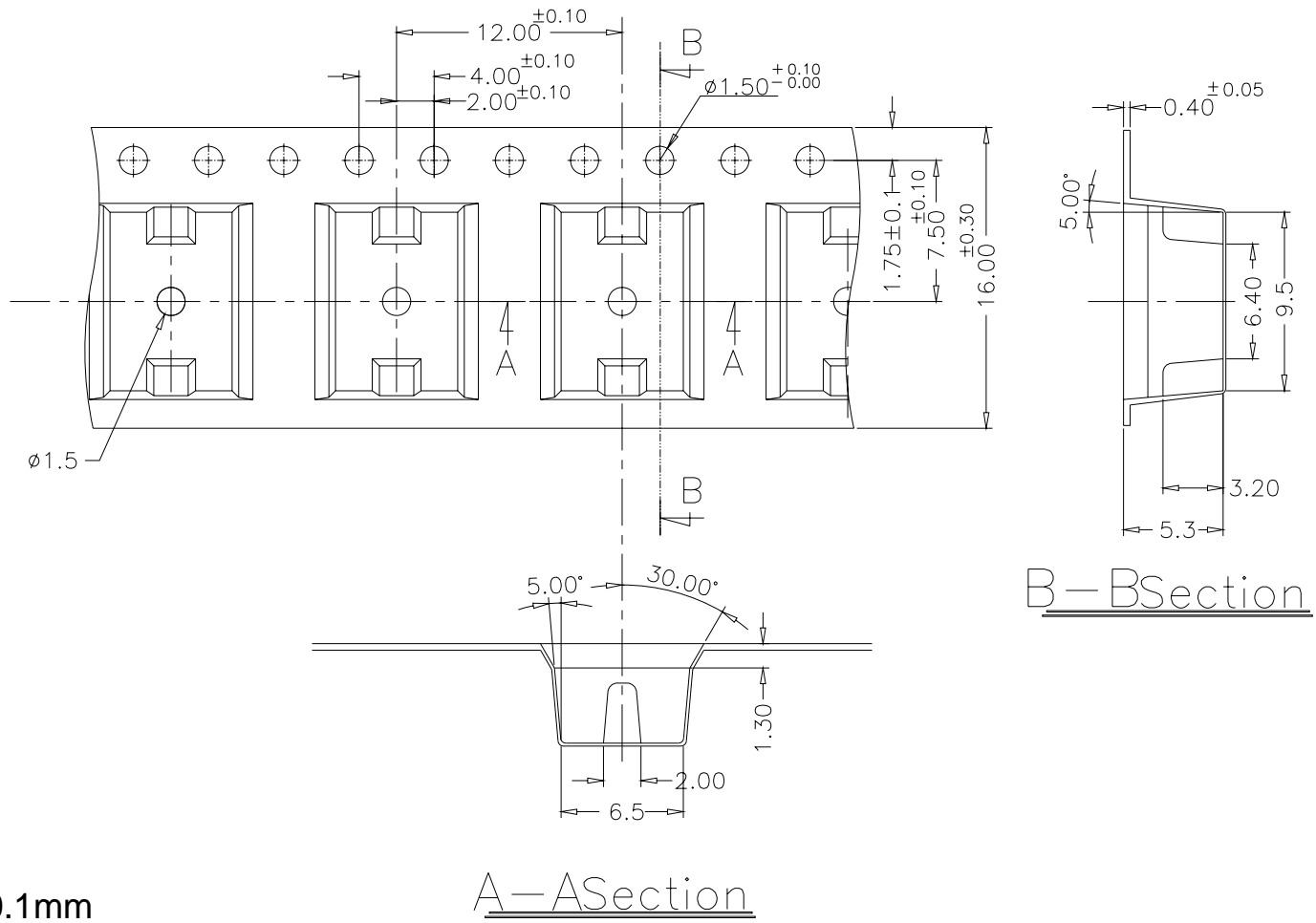

General Tolerance : ± 0.1 mm

DTSM-64 REEL

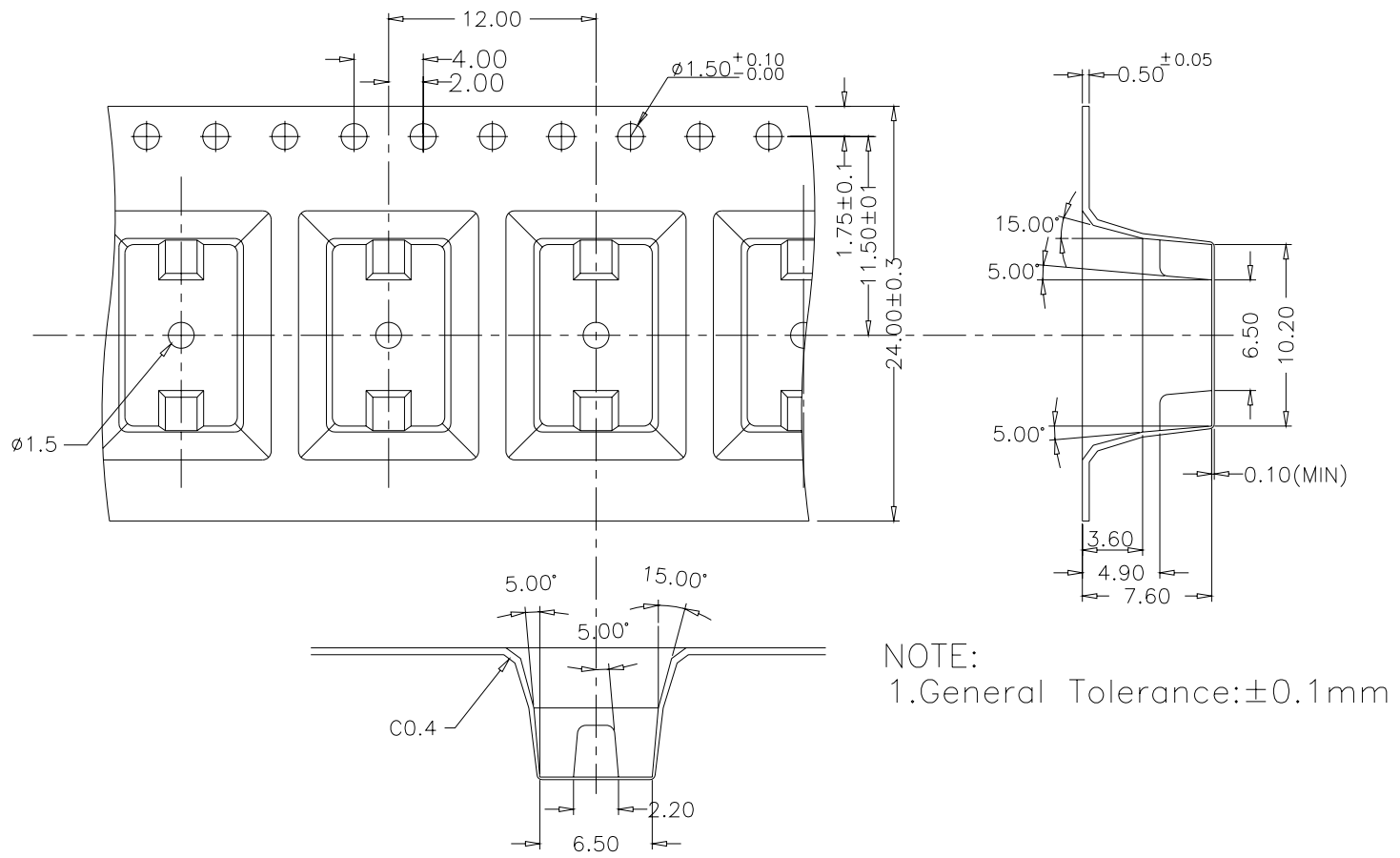

NOTE:
1. General Tolerance: ± 0.1 mm

DTSM-65 REEL

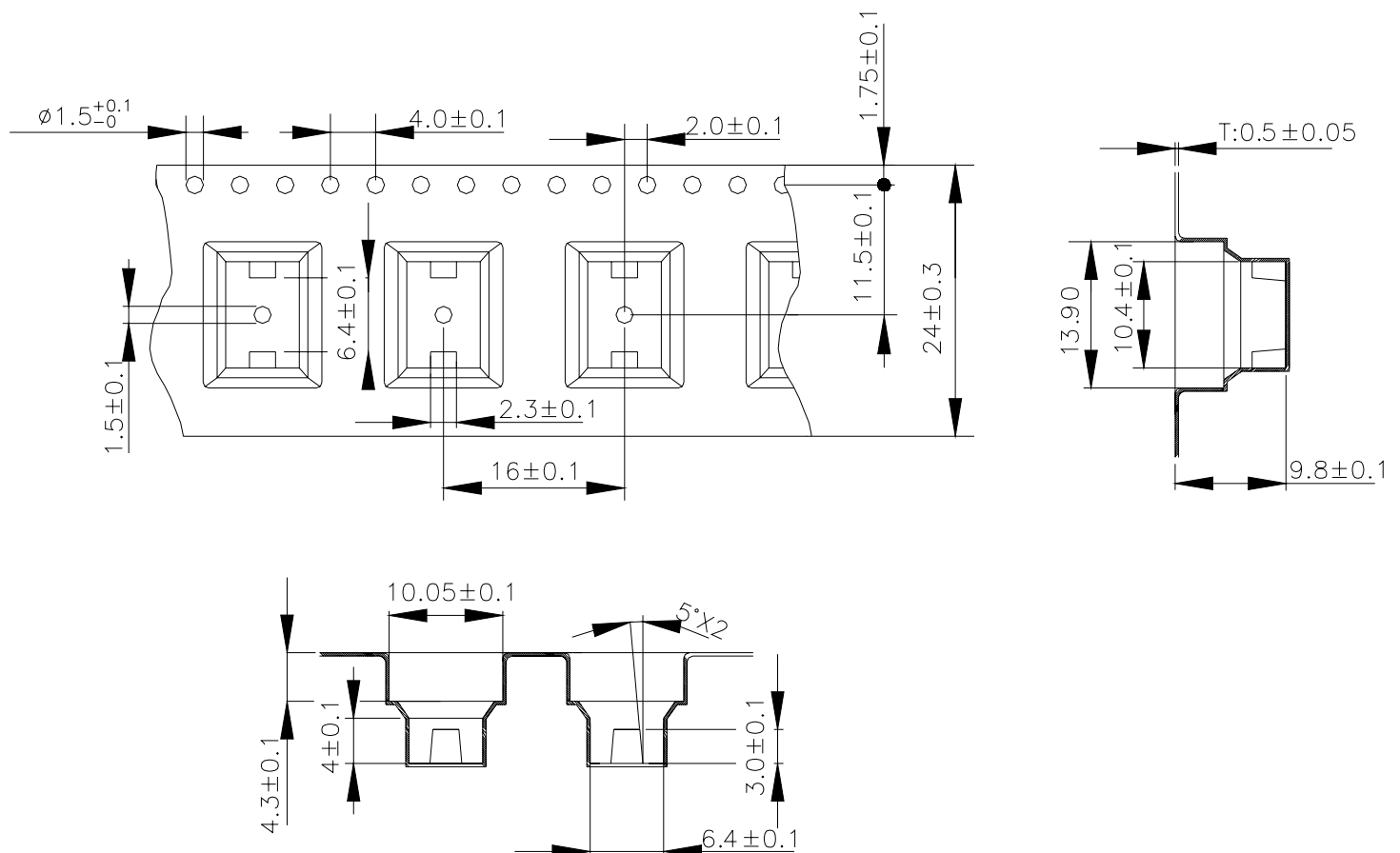

General Tolerance : ± 0.1 mm

DTSMG-61.62.63.64.65 REEL

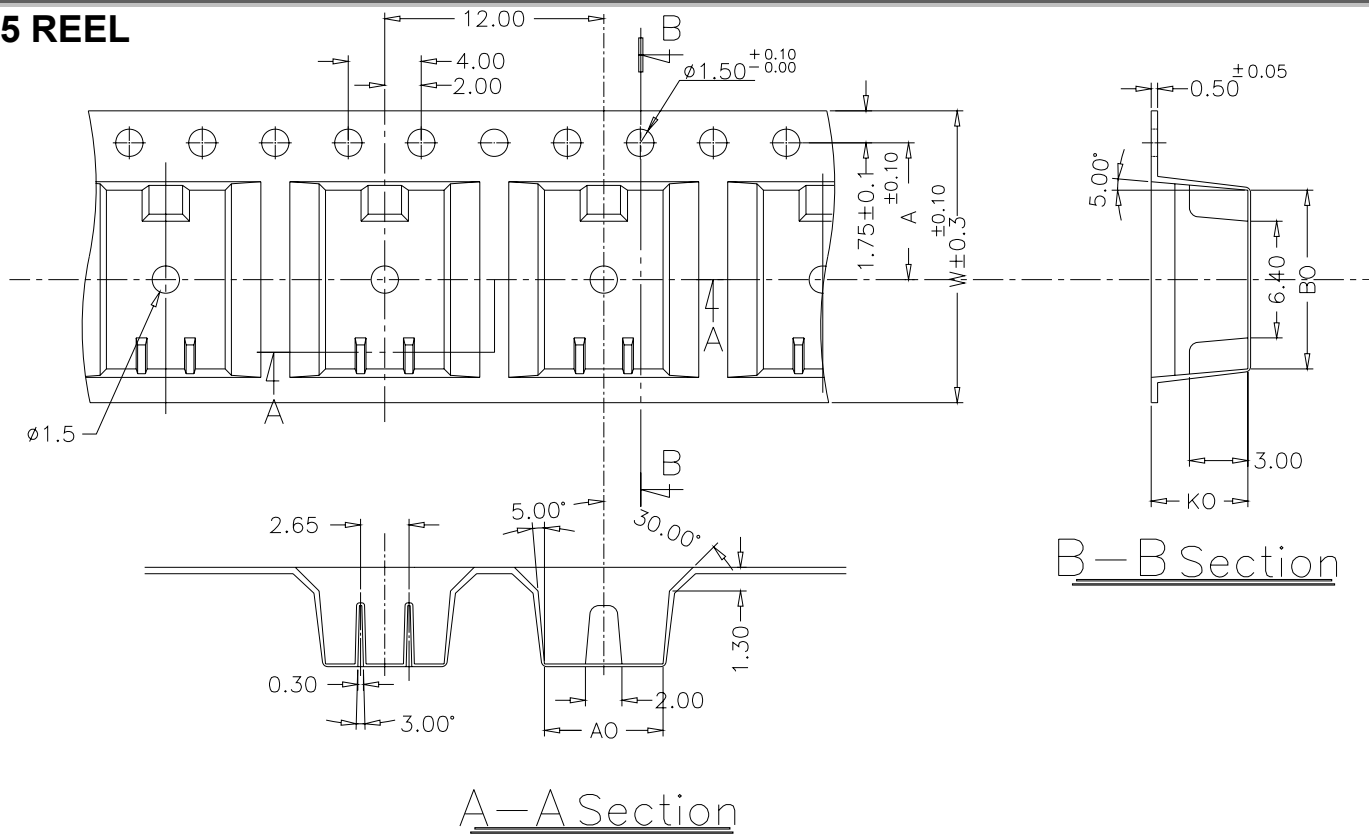

| | | | | | |
|-------------|------|------|------|------|-------|
| DTSMG-65 | 6.50 | 9.50 | 9.75 | 24.0 | 11.50 |
| DTSMG-63.64 | 6.50 | 9.50 | 7.40 | 24.0 | |
| DTSMG-61.62 | 6.50 | 9.50 | 5.30 | 16.0 | 7.50 |
| PART NAME: | AO | B0 | K0 | W | A |

General Tolerance : ±0.1mm

DTSM-61.62 TUBE

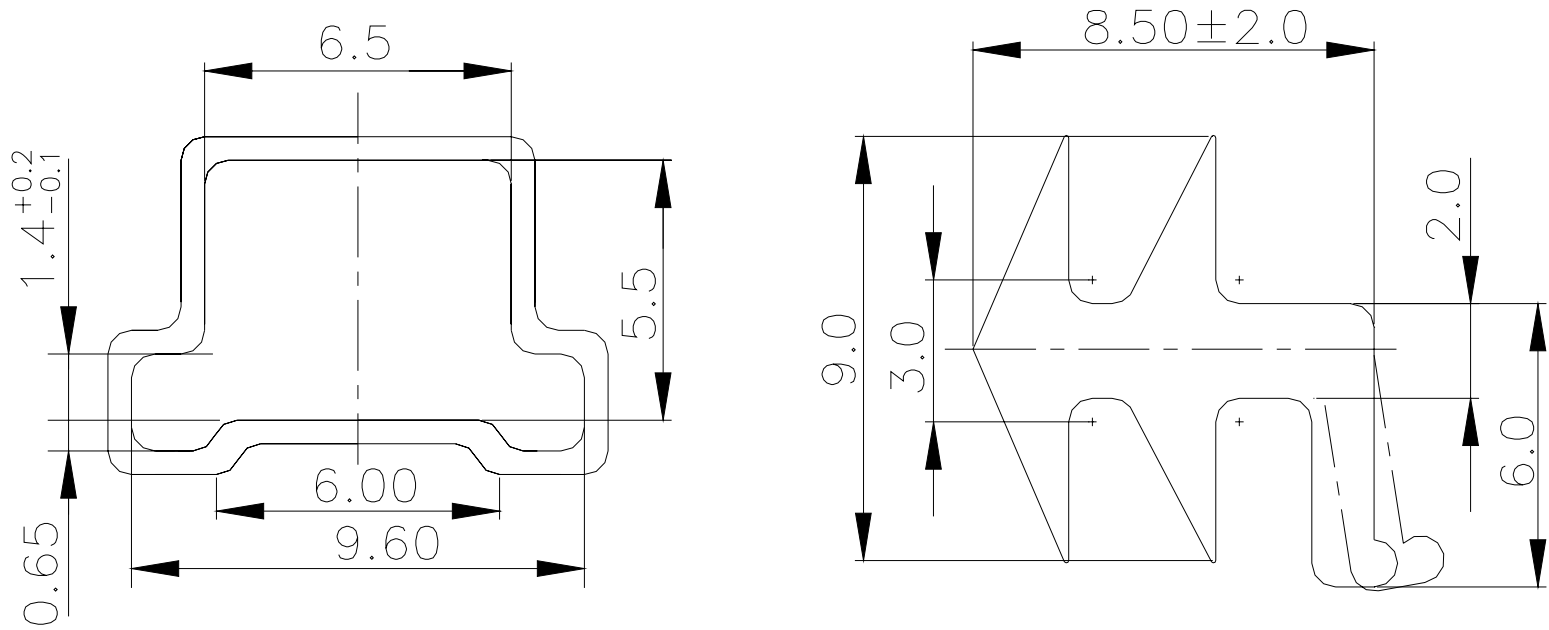

General Tolerance : ±0.2mm

DTSM-63.644(8) TUBE

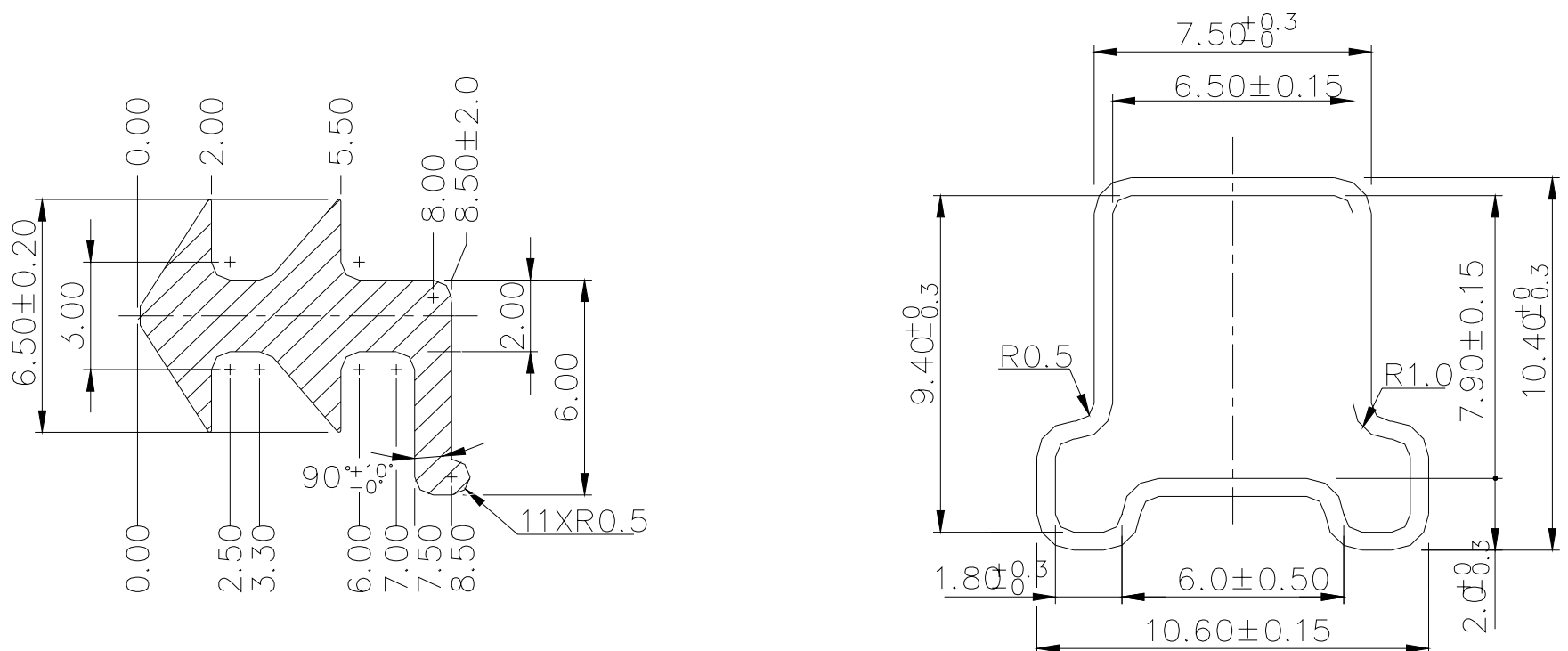

General Tolerance : ±0.2mm

DTSM-65.66 TUBE

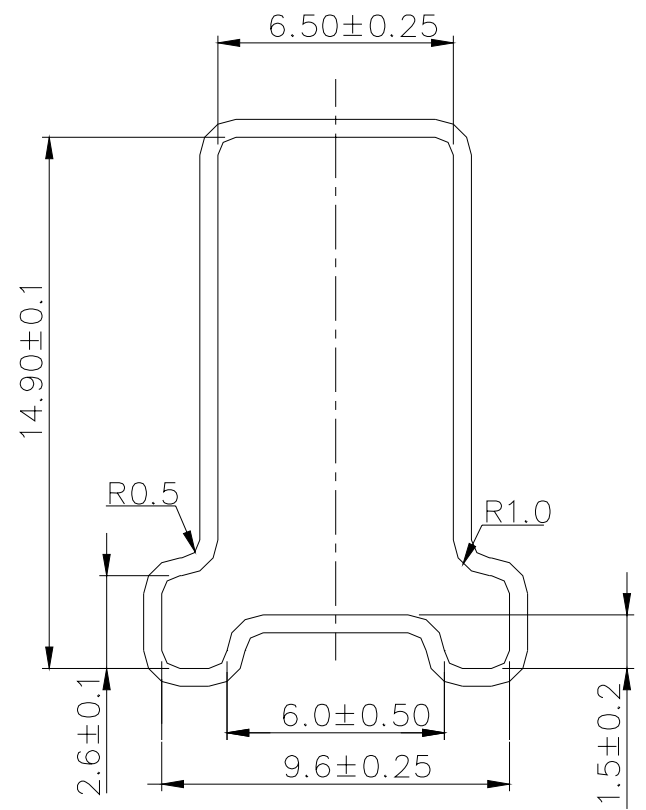
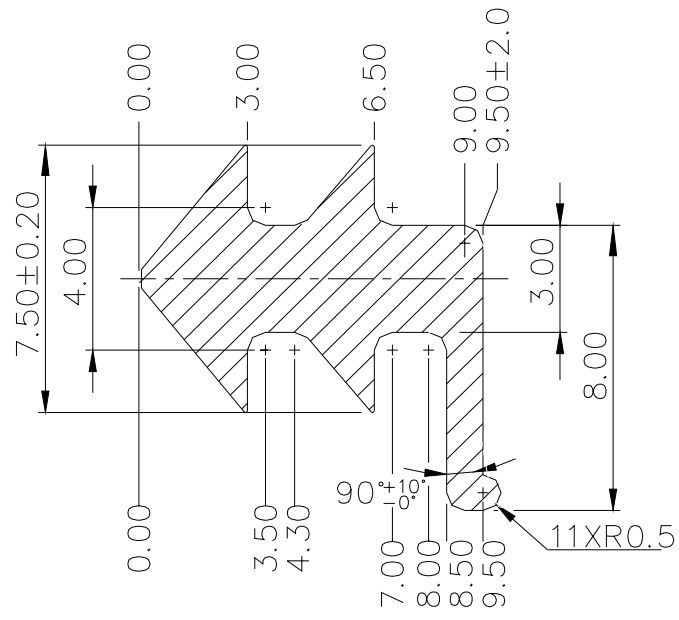

General Tolerance : ±0.2mm

DTSM-2 TUBE

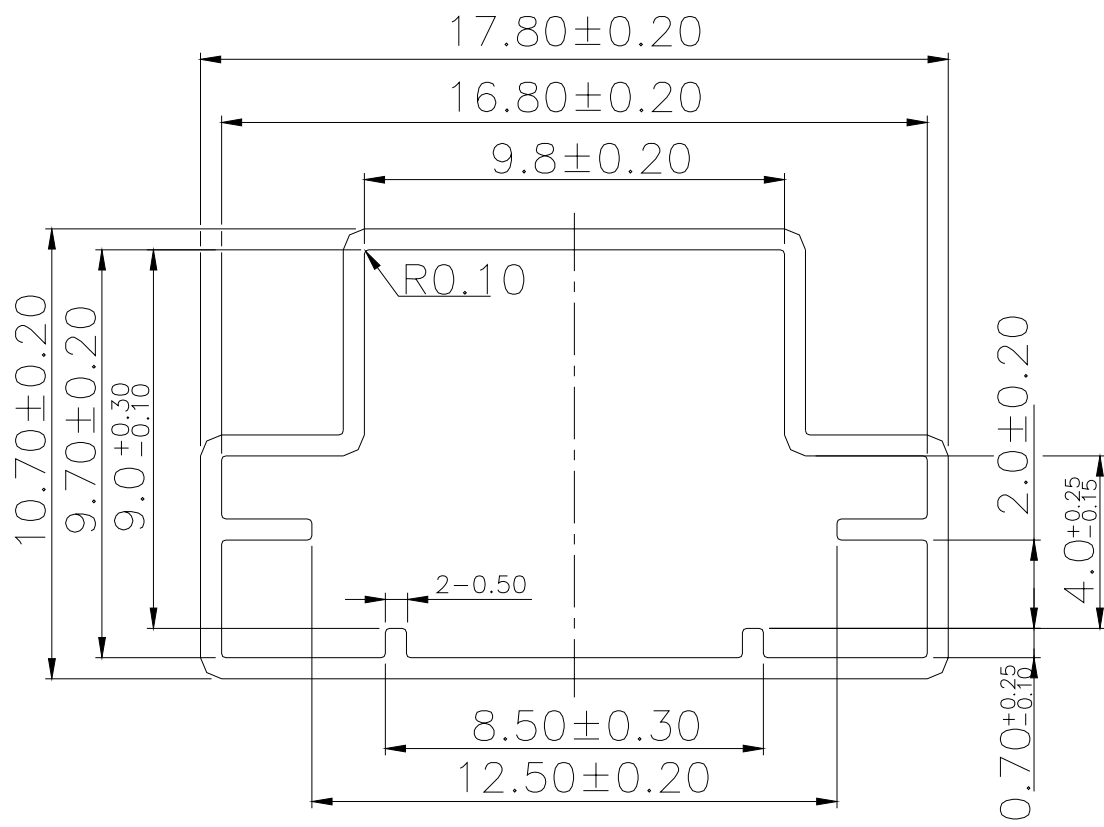

General Tolerance : ±0.2mm

DTS-2 TUBE

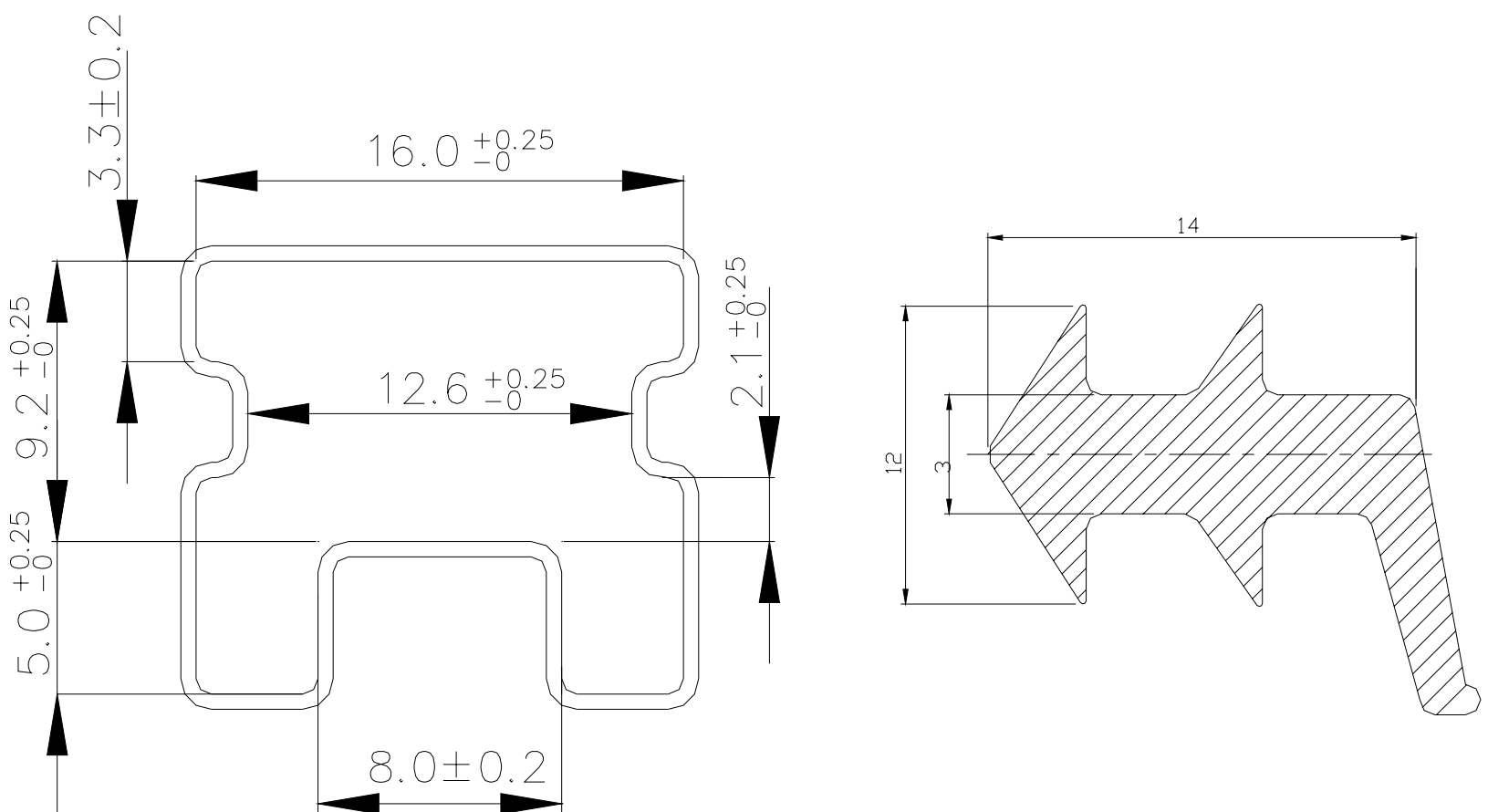

General Tolerance : ±0.2mm